



*Selaras Lawang Sewu*  
Door & Window Solution

# KATALOG ALL BRAND

2022

Our Products  
Available on :

 | AUTODESK  
REVIT

★★★★★  
**TORMAX**  
AUTOMATIC  
SWISS

**SCHNELL**  
panel

**P & M**

**KÜPPE**

**G:BD:**  
ITALY

**AMK**  
AUTOMATIC SWISS



# Selaras Lawang Sewu

Door & Window Solution

## About PT Selaras Lawang Sewu

PT. Selaras Lawang Sewu engaged in Architectural Hardware which includes the Automatic Door, Manual Door and glass door accessories & window, also PT. Selaras Lawang Sewu is one of the world leading project companies of healthcare & manufacturing company for modular room system and their components in the field of OT room and other critical care room in the hospital has gained the trust and recognition from national and international. The recognition makes us appointed as sole distributors in Asia, especially in Indonesia.

With the principle of being doors leader in Indonesia starting from Sabang to Merauke, we make improvement & innovation continuously to all of our products and services, because to us customer satisfaction is important.

## CERTIFICATION

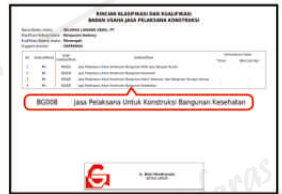

## TORMAX Certification



## ISO Certification



Occupational Health & Safety



Quality Management System



Environmental Management System

# Contents

**02**

## **TORMAX**

Automatic Door  
Hermetic Door  
Hermetic X-Ray Door  
Cobalt Door

**14**

## **SCHNELL PANEL**

Sandwich Panel EPS  
Sandwich Panel PIR  
Enamel Panel

**16**

## **KUPPE**

Automatic Door  
Manual Door  
MOT Accessories

**36**

## **AMK**

Steel Door  
Aluminium Door  
Automatic Door

**44**

## **P&M**

Folding Door  
Variotec Door  
Sliding Door

**52**

## **GBD**

Linac Door  
Brachytherapy Door  
Automatic Sliding Gate  
Automatic Swing Gate  
Automatic Garage Door

**60**

## **PROJECT REFERENCES**

**63**

## **AFTER-SALES SERVICE**

# Automatic Revolving Door



REVOLVING CLASSIC LS 5351 CL



REVOLVING FULL GLASS 5251 FG

**illustration**

Three winged

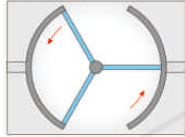

Four winged



**illustration**

Three winged

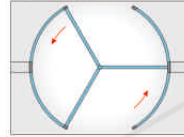

Four winged



FLOOR MOUNTED DRIVES



ACCESS CONTROL



DISPLAY ACCESS



ILLUMINATION





SAFETY SENSOR



NIGHT CLOSURE DOORS

# Revolving Door Technical Data

	CLASSIC LS 5351 CL	FULL GLASS LS 5251 FG
Diameter (mm)	1880 - 4970	1850 - 3370
Passage height (mm)	2200 - 2300	2200 - 2300
Capacity (pers/ hour)	1600 - 3200	800 - 1400
Number of wings	( < ) ( X )	( < ) ( X )
Canopy height (mm) Use	300 - 50 mm 	25 mm 
Open position / Break out	Standard ( < ) ( X )	Optional ( < ) ( < )
Material wings	Aluminium	Aluminium
Material drum wall	Aluminium	Stainless steel 304
Glass quality door wings	8mm ESG Tempered	12mm ESG Tempered
Glass quality drum wall	8,76mm VSG curved laminated	17mm VSG curved laminated
Illumination	LED Spotlight	LED Spotlight
Activation sensor	4 sensors	4 sensors
Safety	Mullion & pro - mullion safety Top scan & heel safety	Mullion & pro - mullion safety Horizontal safety rubber
Locking	Manual / Automatic lock	Manual / Automatic lock
Showcase	Optional	( < ) ( < ) ( X )
Showcase Sliding / Swing	Optional	( < ) ( < )
International Protection Class	IP 22	
Power consumption	Start 350 watt	
Max torque on the door shaft	340 Nm	

# Automatic Sliding Door



STANDARD SLIDING DOOR

**LS 2201 SS**  
 Single Door

**LS 2302 SS**  
 Single Door

**LS 2401 SS**  
 Single Door

**LS 2201 SD**  
 Double Door

**LS 2302 SD**  
 Double Door

**LS 2401 SD**  
 Double Door

**illustration**



Two leaves, opening to both sides.

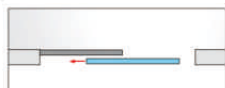

One leaf, opening to the right or to the left



CURVED SLIDING DOOR

**LS 2201 CS**  
 Single Door

**LS 2302 CS**  
 Single Door

**LS 2401 CS**  
 Single Door

**LS 2201 CD**  
 Double Door

**LS 2302 CD**  
 Double Door

**LS 2401 CD**  
 Double Door

**illustration**



Two leaves, opening to both sides



One leaf, opening to the right or to the left



ANGULAR SLIDING DOOR

**LS 2201 AD**  
 Double Door

**LS 2302 AD**  
 Double Door

**LS 2401 AD**  
 Double Door

**illustration**



\*Angular can be custom by order

# Automatic Sliding Door



TELESCOPIC SLIDING DOOR

LS 2201 TLS  
Single Door

LS 2302 TLS  
Single Door

LS 2401 TLS  
Single Door

LS 2201 TLD  
Double Door

LS 2302 TLD  
Double Door

LS 2401 TLD  
Double Door

**illustration**

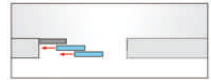

\*Design can be custom more than 4 leaves



BREAK - OUT SYSTEM

LS 2201 BD

LS 2302 BD

**illustration**

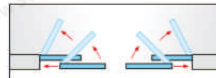

Two leaves, opening to both sides, opening width sliding

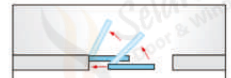

One leaf, opening to the right or to left, opening width sliding

**SLIDING  
DOOR  
DRIVE**

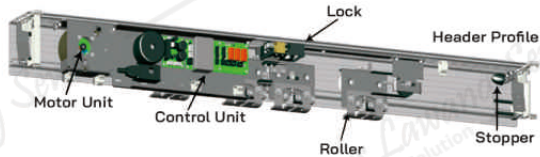

**INCLUDE ACCESSORIES**



Control Unit



Lock Electric



Roller



Guide Rail



Anti Lift



Motor Unit



Control Panel

**OPTIONAL ACCESSORIES**



Foot Switch



Wireless Push Button



Key Switch



Elbow & Foot Switch



Touchless Switch



Remote to Channel

# Automatic Sliding Door (Special Design)



ON GLASS

**LS 2201 OGS**  
Single Door

**LS 2302 OGS**  
Single Door

**LS 2401 OGS**  
Single Door

**LS 2201 OGD**  
Double Door

**LS 2302 OGD**  
Double Door

**LS 2401 OGD**  
Double Door

**illustration**



LEANING DOOR

**LS 2201 LS**  
Single Door

**LS 2201 LD**  
Double Door

**LS 2302 LS**  
Single Door

**LS 2302 LD**  
Double Door

**LS 2401 LS**  
Single Door

**LS 2401 LD**  
Double Door

**illustration**

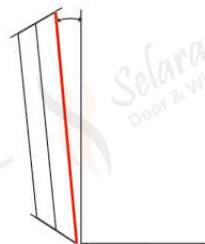

FOLDING DOOR

**LS 2201 F**

**LS 2401 F**

**illustration**

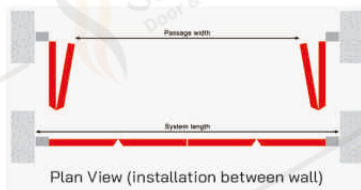

Plan View (installation between wall)



# Automatic Sliding Door Technical Data

	iMotion Customizing	iMotion LS 2401	iMotion LS 2302	Windrive LS 2201
Motor type	Gearless synchronous AC motor	Gearless synchronous AC motor	Gearless synchronous AC motor	Tormax motor with cooling device
Processor	Digital microprocessor c/w error detection, Historical data,	Digital microprocessor c/w error detection, Historical data,	Digital microprocessor c/w error detection, Historical data,	Digital microprocessor c/w error detection, Historical data,
Historical	Digital adjustable	Digital adjustable	Digital adjustable	Digital adjustable
Digital	function, basis for UN/	function, basis for UN/	function, basis for UN/	function, basis for UN/
Basis	CAN interface, Auto	CAN interface, Auto	CAN interface, Auto	CAN interface, Auto
Auto	learning, Auto reversing	learning, Auto reversing	learning, Auto reversing	learning, Auto reversing
Max. Leaf weight single	> 1x500 kg	1x450 kg	1x200 kg	1x120 kg
Double	> 2x400 kg	2x300 kg	2x180 kg	2x100 kg
Telescopic 2 leaf	> 2x250 kg	2x120 kg	2x100 kg	2x100 kg
Telescopic 4 leaf	> 4x150 kg	4x100 kg	4x100 kg	4x80 kg
<b>Opening speed ★★★★★</b>	<b>&gt; 16-100cm/s</b>	<b>8-200cm/s</b>	<b>10-200cm/s</b>	<b>16-160cm/s</b>
<b>Closing speed ★★★★★</b>	<b>&gt; 16-100cm/s</b>	<b>8-160cm/s</b>	<b>10-160cm/s</b>	<b>16-160cm/s</b>
Hold open time	0.5-60 s	0.5-60 s	0.5-60 s	0.5-120 s
Lock	Electric lock	Electric lock direct to trolley	Electric lock direct to trolley	Electric lock direct to trolley
Facility input	8	8	8	7
Output	3	3	3	3
Interfaces	LIN Bus, CAN Bus, RS 232 1x230/1x115 VAC 50...60Hz, 10A	LIN Bus, CAN Bus, RS 232 1x230/1x115 VAC 50...60Hz, 10A	LIN Bus, CAN Bus, RS 232 1x230, 50...60Hz, 10A	LIN Bus 1x230/1/115 VAC 50...60Hz, 10A
Power consumption	300-1000 W	Max 310 W	Max 190 W	13... 200 W
Protection Class	IP 22	IP 22	IP 22	IP 22
Test according to		DIN 18650, EN 60355-1, EN 61000-6-2 EN 61000-6-3	DIN 18650, EN 60355-1, EN 61000-6-2 EN 61000-6-3	EN 12100, EN 60355-1 EN 61000-6-3, performance level c acc DIN EN ISO 13849-1:2008
Certification	 CE RoHS, TÜV, ETL	CE RoHS, TÜV, ETL	CE RoHS, TÜV, ETL	CE RoHS, TÜV, ETL

Cross section

Order by request

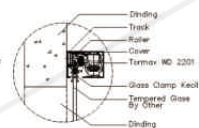
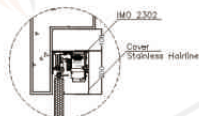
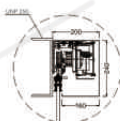

# Automatic Swing Door



SWING DOOR

**Type**    **Type of Opening**    **Mounting**    **Type of linkage**

Single-leaf

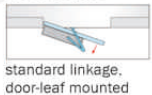
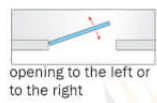

standard linkage,  
lintel mounted

standard linkage,  
door-leaf mounted

**Type**    **Type of Opening**    **Mounting**    **Type of linkage**

Double-leaf

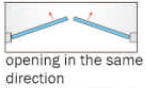

opening in the same  
direction



two-way opening



■ lintel mounted  
■ door-leaf mounted

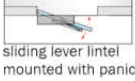
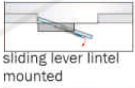

sliding lever lintel  
mounted

sliding lever lintel  
mounted with panic fitting

- LS 1102 SS**  
Smart Drive Single
- LS 1301 SS**  
i-Motion Single
- LS 1401 SS**  
i-Motion Single

- LS 1102 SD**  
Smart Drive Double
- LS 1301 SD**  
i-Motion Double
- LS 1401 SD**  
i-Motion Double



"SPECIAL DESIGN"  
SWING INVISIBLE DRIVE UNIT

- LS 1401 IS**  
i-Motion Single

- LS 1401 ID**  
i-Motion Double

**Type**    **Type of Opening**    **Mounting**    **Type of linkage**

Invisible Drive Solution

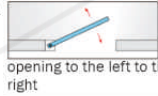

opening to the left to the  
right

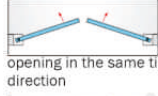

opening in the same time  
direction



two-way opening



■ in the ceiling  
■ in the floor  
■ in the cellar ceiling

# Swing Door Technical Data

	I - Motion LS1401	I - Motion LS1301	Smart Drive LS1102
Dimensions L x W x H	450 x 293 x 127 mm	640 x 135 x 100 mm	640 x 128 x 85 mm
Main connection	1 x 230/ 1 x 115 VAC, 50...60 Hz, 10 A	1 x 230/ 1 x 115 VAC, 50...60 Hz, 10 A	115 V AC/ 60 Hz or 230 VAC/ 50 Hz
Power consumption	6 - 250 W	6 - 250 W	3 - 140 W
Sensor power supply	24 V DC/ 0.75 (1.5) A	24 V DC/ 0.75 A	24 VDC
Ambient temperature	-20 C to + 50° C	-20 C to + 50° C	-20 C to + 50° C
Protective class	IP 55 control unit, IP 67 drive unit	IP 22	IP 22
Hold open time	0 - 60° s; permanently open	0 - 60° s; permanently open	Adjustable 0 - 60° s
Opening & closing speed	max. 45° / s	Can be set up to max. of 45° / s	Adjustable
Inputs	8 programmable input	8 programable input, of which 4 testable safety features, expandable by modules	6 (activators, 2 safety devices, operating modes off and open, key switch
Output	3 programmable	3 programmable, short circuit proof, expandable by modules	3 (electric lock control, status, signal door position closed or open, safety device monitoring)
Interfaces	LIN Bus, CAN Bus, RS232	LIN Bus, CAN Bus, RS232	LIN Bus, CAN Bus, RS232
Capacity			

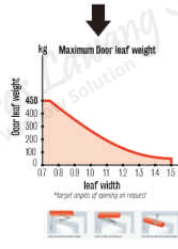
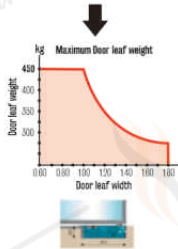

## Swing Door References



# Tormax Medical Sector



**SLIDING HERMETIC SINGLE**

## HRM 2403 S

- Motor type : TORMAX with coding device
- Processor : Digital micro processor with error detection
- Historical : Historical data
- Opening speed : 5 ..... 35 cm/s
- Closing speed : 5 ..... 35 cm/s
- Hold open time : 0,5 ..... 120 second
- Main connection : 1 phase, 230/115 VAC, 50/60 Hz
- Power consumption : 13 ..... 200 watt
- Protecting class : IP 22
- Ambient temperature : 10° ..... 500° C



**SLIDING HERMETIC DOUBLE**

## HRM 2403 D

- Motor type : TORMAX with coding device
- Processor : Digital micro processor with error detection
- Historical : Historical data
- Opening speed : 10 ..... 70 cm/s
- Closing speed : 10 ..... 70 cm/s
- Hold open time : 0,5 ..... 120 second
- Main connection : 1 phase, 230/115 VAC, 50/60 Hz
- Power consumption : 13 ..... 200 watt
- Protecting class : IP 22
- Ambient temperature : 10° ..... 50° C

### illustration

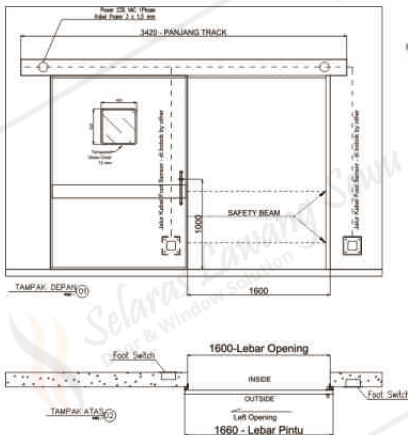

### illustration

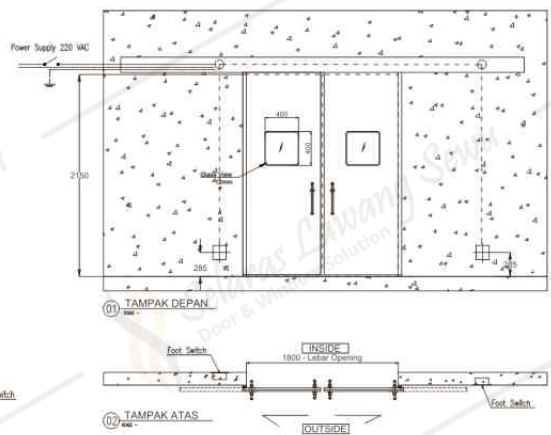

# Tormax Medical Sector



**SWING HERMETIC SINGLE**

## HRM 1102 S

- Drive Type : Tormax 1102 Swing door drive
- Drive System : Electro-mechanical drive with DC motor, extensible with modules, spring activated closing or opening
- Opening Angle : 70° .....110° max
- Speed : 5...60°/second max
- Closing Speed : 5...60°/second max
- Hold open timer : 1...60 second
- Main connection : 230/115 VAC, 50/60 Hz
- Power consumption : 3...140 watt
- Protective class : IP 20
- Ambient temperature : 10-50°C
- Capacity : Up to 1000mm door width/leaf



**SWING HERMETIC DOUBLE**

## HRM 1102 D

- Drive Type : Tormax 1102 Swing door drive
- Drive System : Electro-mechanical drive with DC motor, extensible with modules, spring activated closing or opening
- Opening Angel : 70° .....110° max
- Speed : 5...60°/second max
- Closing Speed : 5...60°/second max
- Hold open timer : 1...60 second
- Main connection : 230/115 VAC, 50/60 Hz
- Power consumption : 3...140 watt
- Protective class : IP 20
- Ambient temperature : 10-50°C
- Capacity : Up to 1000mm door width/leaf

### illustration

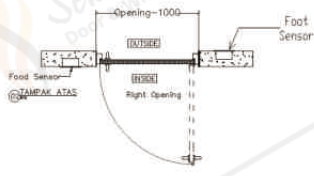
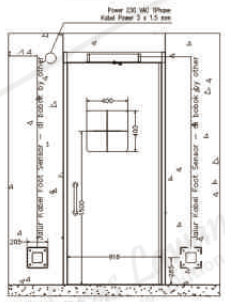

### illustration

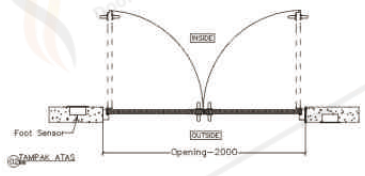
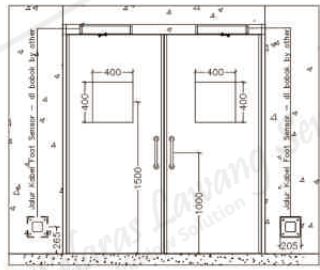

# Tormax Medical Sector



**SLIDING HERMETIC X - RAY**

**HRM 2403 SR**    **HRM 2403 DR**  
Single Door      Double Door

Detail	Single Door	Double Door
Motor type	TORMAX with coding device	TORMAX with coding device
Processor	Digital micro processor	Digital micro processor
Opening speed	10 ..... 30 cm/s	20 ..... 60 cm/s
Closing speed	10 ..... 35 cm/s	10 ..... 35 cm/s
Hold open time	0,5 ..... 60 second	0,5 ..... 60 second
Main connection	1 phase, 230VAC, 50/60 Hz	1 phase, 230VAC, 50/60 Hz
Power consumption	20 ..... 300 watt	20 ..... 300 watt
Protecting class	IP 22	IP 22
Ambient temperature	10 ..... 50 °C	10 ..... 50 °C



**COBALT DOOR**

**HRM 24X1 SR**

## Technical Data

Stainless steel plate door thickness 1.5mm	1 unit
Tormax automatic drive capacity 2500kg	1 unit
Safety beam sensor	1 set
Rack 2m	1 unit
Foot switch	2 pcs
Monorail system 2000kg with trolley	1 unit
Bracket	1 unit
Machine cover stainless steel SUS 304	1 unit
Lead 5mm	1 unit
Stainless steel handle inside / outside	1 unit



**TELESCOPIC ICU/ICCU**

**HRM 2201 TLS**    **HRM 2201 TLD**  
Single Door      Double Door

## Technical Data

Tormax automatic drive	1 unit
Tormax control panel	1 unit
Header profile with rubber shock absorber	2 pcs
Aluminium anodized cover	1 unit
Polyamid double roller	1 unit
Electromagnetic lock	1 unit
Safety beam sensor	1 unit
Touchless sensor (inner & outer)	1 unit

**TORMAX Hermetic X-Ray illustration**

Single Door

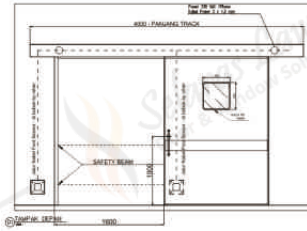

Double Door

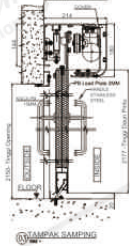
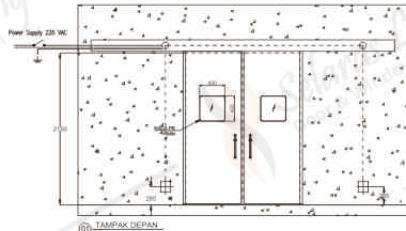

**TORMAX Cobalt Door illustration**

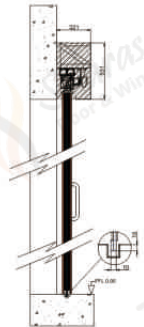
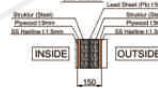
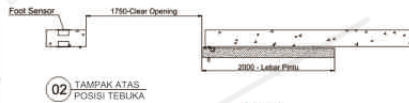
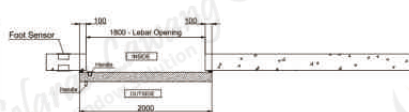
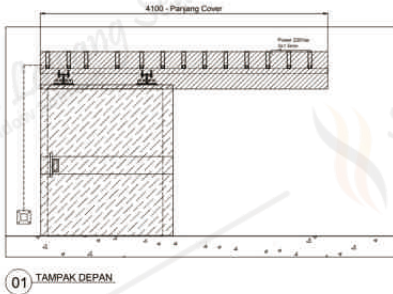

**TORMAX Telescopic ICU/ICCU illustration**

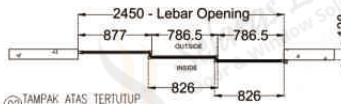
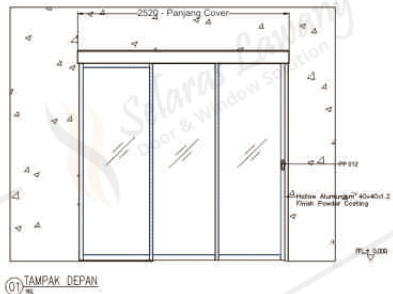

# Sandwich Panel EPS FR & PIR



SANDWICH PANEL EPS FR

**HRM SN01 S**  
Thickness 50mm

**HRM SN02 S**  
Thickness 75mm

**HRM SN03 S**  
Thickness 100mm

**HRM SN04 S**  
Thickness 150mm

**HRM SN05 S**  
Thickness 200mm

## Specification Table EPS FR

1	Material Plate	Zinc Alumel
2	Plate Thickness	
	- Wall	up to 0,6mm
	- Ceiling	up to 0,6mm
3	Coating Thickness	up to 60 micron
4	Coating Type	Anti Bacterial
5	Coating Color	Off White
6	Effective Width Dimension	1000mm / 1160mm
7	Max. Length Panel	up to 12 meters
8	Panel Thickness	50mm, 75mm, 100mm, 150mm, 200mm
9	EPS Type	Fire Retardant
10	EPS Density	18 kg / m <sup>3</sup>



SANDWICH PANEL PIR

**HRM SN06 S**  
Thickness 50mm

**HRM SN07 S**  
Thickness 75mm

**HRM SN08 S**  
Thickness 100mm

**HRM SN09 S**  
Thickness 150mm

**HRM SN10 S**  
Thickness 200mm

## Specification Table PIR

1	Material Plate	Zinc Alumel
2	Plate Thickness	
	- Wall	up to 0,6mm
	- Ceiling	up to 0,6mm
3	Coating Thickness	up to 60 micron
4	Coating Type	Anti Bacterial
5	Coating Color	Off White
6	Effective Width Dimension	1000mm / 1160mm
7	Max. Length Panel	up to 12 meters
8	Panel Thickness	50mm, 75mm, 100mm, 150mm, 200mm
9	PIR Type	Fire Retardant
10	PIR Density	40 kg / m <sup>3</sup>

## Sandwich Panel Illustration

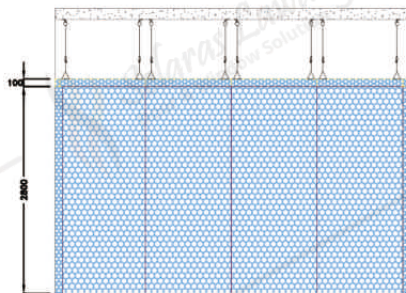

01 POTONGAN  
SCL



# Enamel Panel



STAINLESS STEEL PANEL

**HRM SN11 S**  
Single

**HRM SN11 D**  
Double

## Specification

### Stainless Steel Panel

- Material Stainless Steel SUS 304 Thickness 0,8mm
- Fire Retardant
- Gypsum Board Fire Stop 13mm
- Rockwool 100kg/m<sup>3</sup>



STAINLESS STEEL COATING PANEL

**HRM SN12 S**  
Single

**HRM SN12 D**  
Double

## Specification

### Stainless Steel Coating Panel

- Material Stainless Steel SUS 304 Thickness 0,8mm
- Fire Retardant
- Gypsum Board Fire Stop 13mm
- Rockwool 100kg/m<sup>3</sup>

## Optional Color



GLASS PANEL

**HRM SN13 S**  
Single

**HRM SN13 D**  
Double

## Specification

### Glass Panel

- Material Stainless Steel SUS 304 Thickness 0,8mm
- Tempered Glass 12mm printing
- Fire Retardant
- Gypsum Board Fire Stop 13mm
- Rockwool 100kg/m<sup>3</sup>

# Automatic Sliding Door



STAINLESS STEEL PANEL

**KP 1041 S**  
Single

**KP 1041 D**  
Double

## Technical Data

1	Unit DC motor	1 unit
2	Control unit	1 unit
3	Position switch	3 unit
4	Aluminium rail	1 unit
5	Safety beam sensor	1 prs
6	Cover	1 prs
7	Nylon roller	2 unit
8	Glass lock	1 unit

# Movable Partition



MOVABLE PARTITION

**KP P80 MP**  
Type 80

**KP P120 MP**  
Type 120

Type	P80	P120
Panel Thickness	80	120
Sound Transmission On Loss (db)	50	58
Particle Board Thickness (mm)	9	12
Max. Panel Height (mm)	6000	12000
Min. Panel Width (mm)	750	800
Panel Weight (kg/m <sup>2</sup> )	40	58
Insulation	<ul style="list-style-type: none"> <li>Rockwool Density 60</li> <li>Reducing Layer</li> </ul>	<ul style="list-style-type: none"> <li>Rockwool Density 100</li> <li>Reducing Layer</li> </ul>
Surface Material	MDF 9mm	MDF 12mm
Material Frame	<ul style="list-style-type: none"> <li>Aluminium Anodized with 3 Rubber Seal (Optional : Powder Coating)</li> <li>Hollow Steel</li> </ul>	
Finishing	Non Finishing (Natural MDF)	
Ceiling & Floor Contacting Mechanism	Rubber Contact For Ceiling & Floor	



**AUTOMATIC ACCESS DOOR**  
**ELC 9318 MF PASS BT RF08**

## Accessories

1	Unit DC motor	1 unit
2	Control unit	1 unit
3	Position switch	3 unit
4	Aluminium rail	1 unit
5	Safety beam sensor	1 prs
6	Cover	1 prs
7	Nylon roller	2 unit
8	Push Button (Inner)	1 unit.
9	Electronic Reader Connection	1 Pcs
	Dekkson ELC 9318 MF PASS BT RF08 (Outer)	

**KUPPE Automatic Sliding Door illustration**

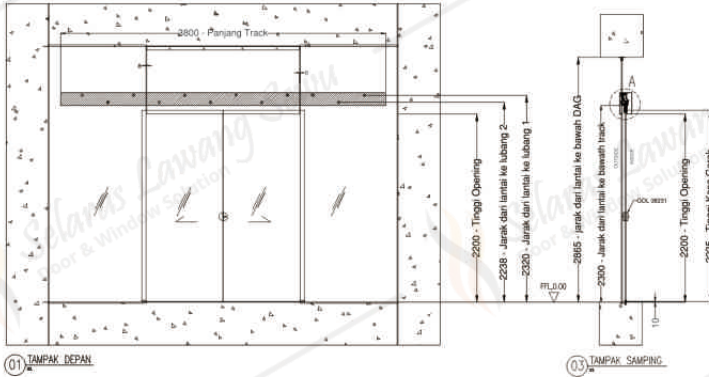

**KUPPE Movable Partition illustration**

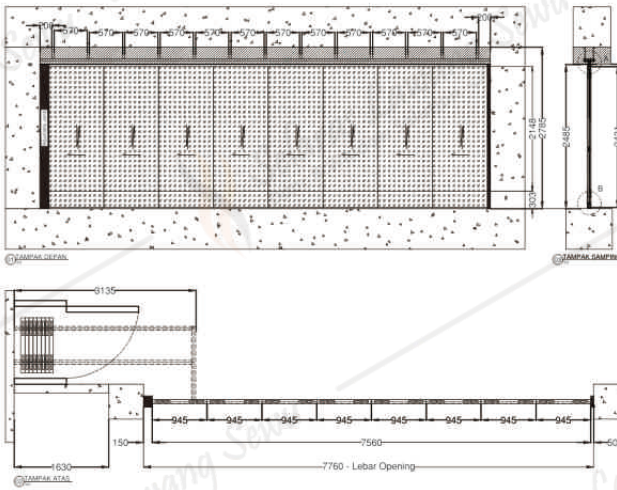

**KUPPE Access Door illustration**

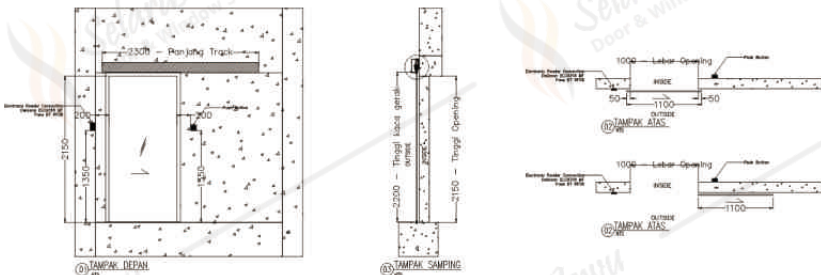

# Manual Steel & Stainless Steel Door



**KP 261 S**  
Single

**KP 261 SG**  
Single + View

**KP 261 D**  
Double

**KP 261 DG**  
Double + View

### Specification

• Door Frame	Steel Plate 1.5mm
• Door Leaf	Steel Plate 1 - 1.2mm
• Door Framework	Made from steel plate 47-50mm thickness
• Accessories	<ul style="list-style-type: none"> <li>» Hinge DKS ESS DL 4x3x3mm 2BB SSS</li> <li>» Lever Handle LHTR 016/22mm</li> <li>» Lockcase MTS IL 8672+Cylinder DKS DC 70mm</li> <li>» Flush Bolt FB SQ 501-270mm &amp; 370mm (for Double Door)</li> </ul>
• Optional	<ul style="list-style-type: none"> <li>» Clear Glass</li> <li>» Louvre (from Steel Plate)</li> <li>» Door Closer</li> </ul>



**KP 260 S**  
Single

**KP 260 SG**  
Single + View

**KP 260 D**  
Double

**KP 260 DG**  
Double + View

### Specification

• Door Frame	Stainless Steel Plate 1.5mm
• Door Leaf	Stainless Steel Plate 1 - 1.2mm
• Door Framework	Made from steel plate 47-50mm thickness
• Accessories	<ul style="list-style-type: none"> <li>» Hinge DKS ESS DL 4x3x3mm 2BB SSS</li> <li>» Pull Handle</li> <li>» Lockcase MTS IL 8672+Cylinder DKS DC 70mm</li> <li>» Flush Bolt FB SQ 501-270mm &amp; 370mm (for Double Door)</li> </ul>
• Optional	<ul style="list-style-type: none"> <li>» Clear Glass</li> <li>» Louvre (from Stainless Steel Plate)</li> <li>» Door Closer DKS DCL 105 NHO NA</li> </ul>



**KP 263 S**  
Single

**KP 263 SG**  
Single + View

**KP 263 D**  
Double

**KP 263 DG**  
Double + View

### Specification

• Door Frame	Steel Plate with outside size 150 x 70 x 1.5mm
• Door Leaf	Steel Plate 1 - 1.2mm
• Inside of the Door	Rockwool
• Door Framework	Made from steel plate 47-50mm thickness
• Accessories	<ul style="list-style-type: none"> <li>» Hinge DKS ESS DL 4x3x3mm 2BB SSS</li> <li>» Pull Handle</li> <li>» Lockcase MTS IL 8672+Cylinder DKS DC 70mm</li> <li>» Flush Bolt FB SQ 501-270mm &amp; 370mm (for Double Door)</li> </ul>
• Optional	<ul style="list-style-type: none"> <li>» Clear Glass</li> <li>» Louvre (from Stainless Steel Plate)</li> <li>» Door Closer DKS DCL 105 NHO NA</li> </ul>

**KUPPE Steel Door illustration**

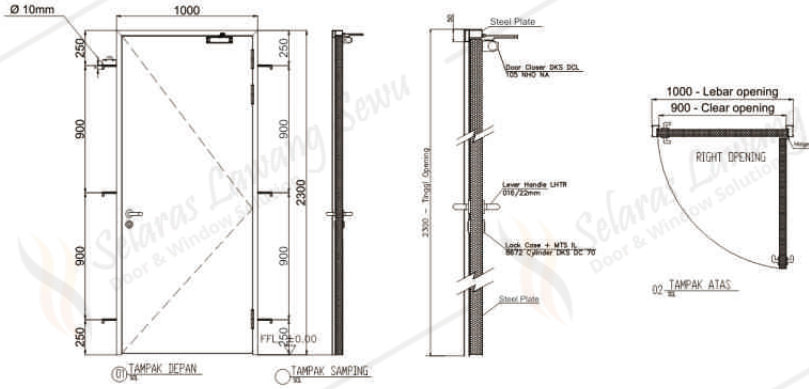

**KUPPE Stainless Steel Door illustration**

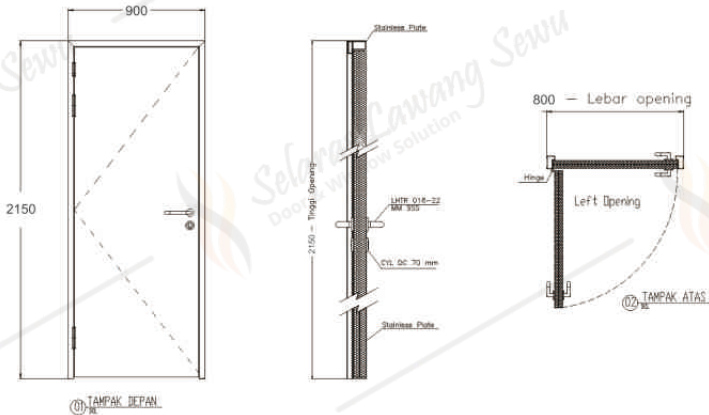

**KUPPE Fire Door illustration**

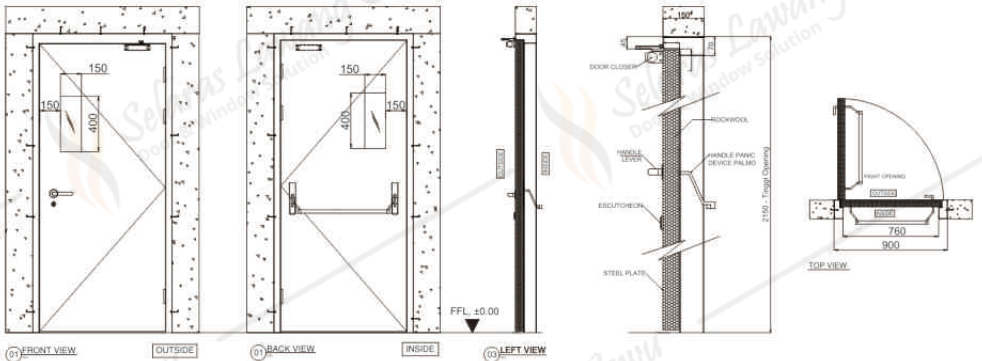

# Manual Lead Door



**KP 261 SR**  
Single

**KP 261 DR**  
Double

**KP 261 SGR**  
Single + View

**KP 261 DGR**  
Double + View

## Specification

• Door Frame	Steel Plate with Lead 2mm
• Door Leaf	Steel Plate with Lead 2mm
• Accessories	<ul style="list-style-type: none"> <li>» Hinge DKS NRP 316 8x4x4mm 6BB SSS</li> <li>» Lever Handle</li> <li>» Lockcase X-Ray + Cylinder</li> <li>» Door Closer DKS DCL 105 NHO NA</li> <li>» Door Seal</li> <li>» Flush Bolt (for Double Door)</li> </ul>
• Optional	Clear Glass with Lead



**KP 260 SR**  
Single

**KP 260 DR**  
Double

**KP 260 SGR**  
Single + View

**KP 260 DGR**  
Double + View

## Specification

• Door Frame	Stainless Steel Plate with Lead 2mm
• Door Leaf	Stainless Steel Plate with Lead 2mm
• Accessories	<ul style="list-style-type: none"> <li>» Hinge DKS NRP 316 8x4x4mm 6BB SSS</li> <li>» Lockcase X-Ray + Cylinder</li> <li>» Lever Handle</li> <li>» Door Closer DKS DCL 105 NHO NA</li> <li>» Door Seal</li> <li>» Flush Bolt (for Double Door)</li> </ul>
• Optional	Clear Glass with Lead

# Steel Lead Door Illustration

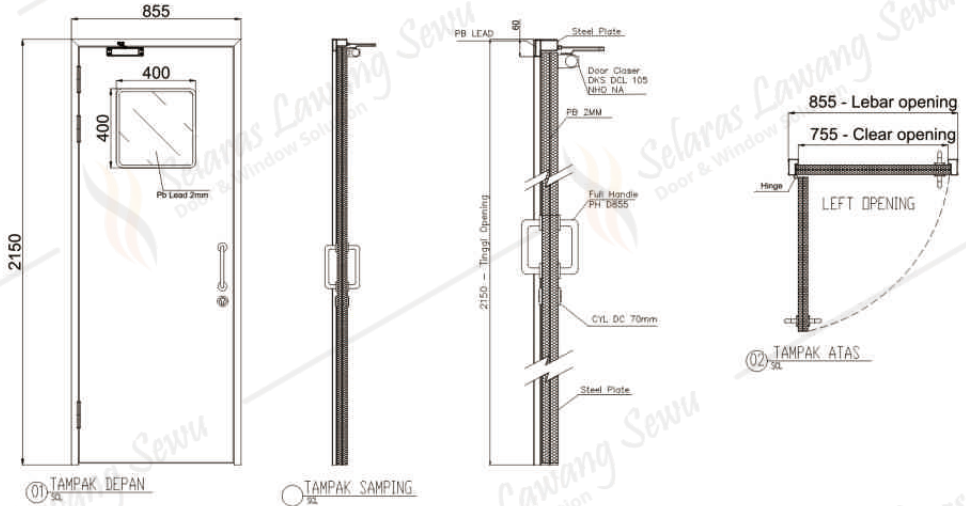

# Stainless Steel Lead Door Illustration

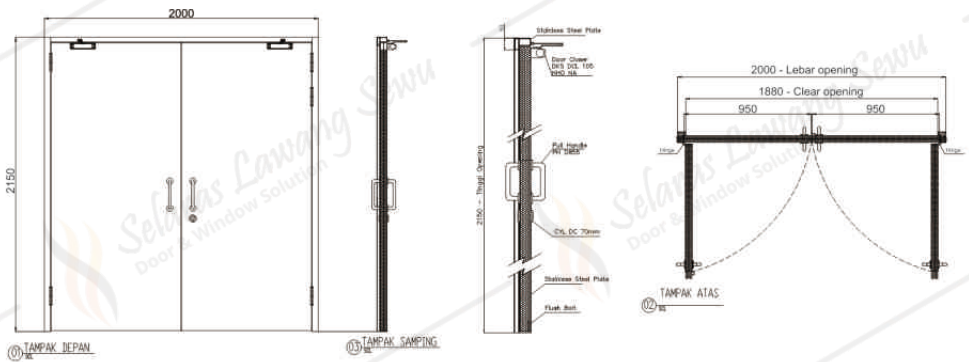

## Manual Steel & Stainless Steel Sliding Door



### Steel Door

**KP 251 S**  
Single

**KP 251 D**  
Double

**KP 251 SG**  
Single + View

**KP 251 DG**  
Double + View

### Stainless Steel Door

**KP 250 S**  
Single

**KP 250 D**  
Double

**KP 250 SG**  
Single + View

**KP 250 DG**  
Double + View

### Specification

• Door Frame	Steel / Stainless Steel Plate 1.5mm
• Door Leaf	Steel / Stainless Steel Plate 1 - 1.2mm
• Door Framework	Made from steel plate 47-50mm thickness
• Track SF 50 / SF 500	
• Roller with POM	
• Hanger Plate	
• Floor Guide	
• U Channel	
• Stopper	
• Bracket	
• Steel / Stainless Steel Rail Cover 1 Ls	
• Accessories	• Handle Stainless • Lockcase + Cylinder
• Optional	Clear Glass

## Manual Steel & Stainless Steel Lead Sliding Door



### Steel Door

**KP 251 SR**  
Single

**KP 251 DR**  
Double

**KP 251 SGR**  
Single + View

**KP 251 DGR**  
Double + View

### Stainless Steel Door

**KP 250 SR**  
Single

**KP 250 DR**  
Double

**KP 250 SGR**  
Single + View

**KP 250 DGR**  
Double + View

• Sliding manual Steel / Stainless Steel with Lead 2mm (Aluminium track can withstand a load of 250kg, length of 3.2m)	
• Sliding manual Steel / Stainless Steel with Lead 4mm (Aluminium track can withstand a load of 500kg, length of 3.2m)	
• Door Framework	: Made from steel / stainless steel plate 47-50mm thickness
• Track SF 50 / SF 500	
• Roller with POM	
• Hanger Plate	
• Floor Guide	
• U Channel	
• Stopper	
• Bracket	
• Steel / Stainless Steel Rail Cover 1 Ls	
• Accessories	• Handle Stainless • Lockcase X-Ray + Cylinder
• Optional	: Clear Glass with Lead



## Manual Steel & Stainless Steel Sliding Door Illustration

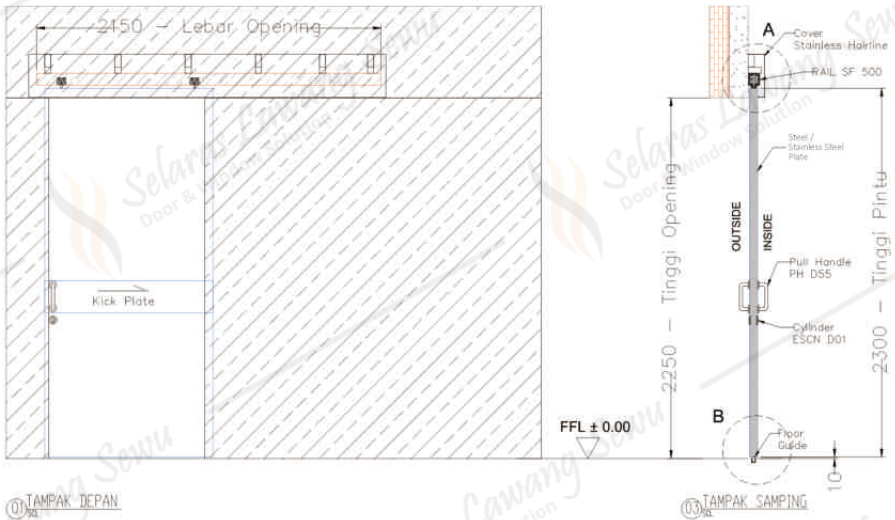

## Manual Steel & Stainless Steel Lead Sliding Door Illustration

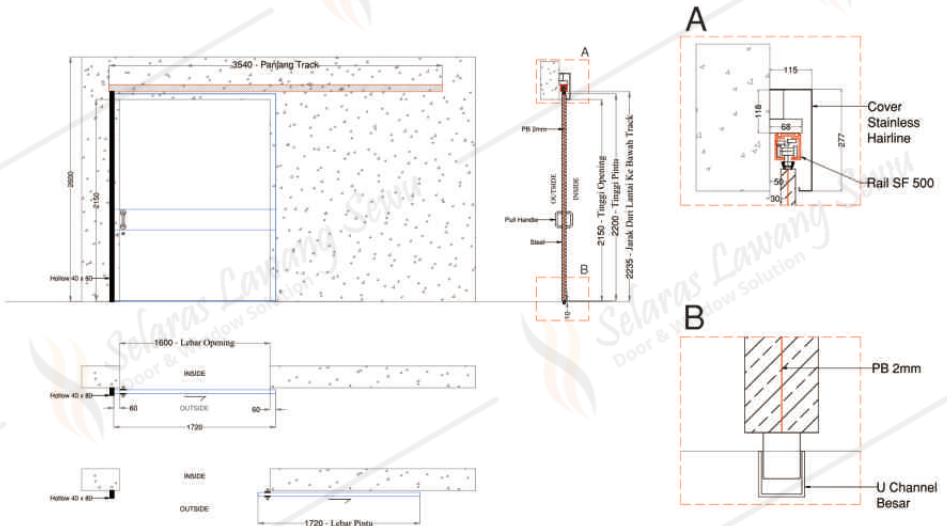

# Kuppe in Medical Sector



**HERMETIC DOOR**

**HRM KP01 S**  
Single

**HRM KP01 D**  
Double

## Specification

Detail	Single Door	Double Door
Opening Size	900mm & 1600mm	2000mm
Height Door	2150mm & 2400mm	2150mm & 2400mm
Door Material	SS Foam Insulated	SS Foam Insulated
Cover Material	Aluminium Anodized Coating	Aluminium Anodized Coating
Handle Material	Stainless Steel	Stainless Steel
Window	400mm x 400mm	400mm x 400mm
Safety Beam Sensor	4 Safety Beam Sensor	4 Safety Beam Sensor
Rubber Seal	4 Sides of The Door	4 Sides of The Door
Delay for Opening	2 - 20s	2 - 20s
Door Force Close	>70N	>70N
Manual Force Close	<100N	<100N
Power Consumption	150VA	150VA



**NON-HERMETIC DOOR**

**HRM KP1041 S**  
Single

**HRM KP1041 D**  
Double

## Specification

Size Opening	Width 1500mm	Height 2150mm
Door Leaf	Steel/Aluminium 0,7mm Powder Coating	
Door Frame	Stainless Steel 304	
Insulation	EPS (Expandable Polystyrene)	
1 Set	Handle DEKKSON	
1 Sheet	Glass View Non-Tempered 6mm	
1 Unit	KUPPE machine	



**INTERLOCK SYSTEM**

**HRM KP32 S**

## Specification

• Indicator Lamp	2 Set
• Power Supply 24 V DC	1 Pcs
• Terminal 12 Pin	1 Pcs
• Relay	4 Set
• Socket Wring	4 Set
• Box Panel	1 Pcs

## KUPPE Hermetic Illustration

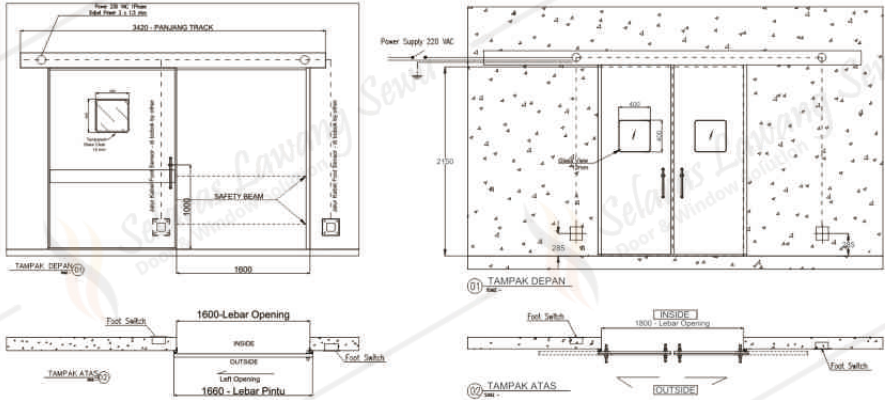

## KUPPE Non-Hermetic Illustration

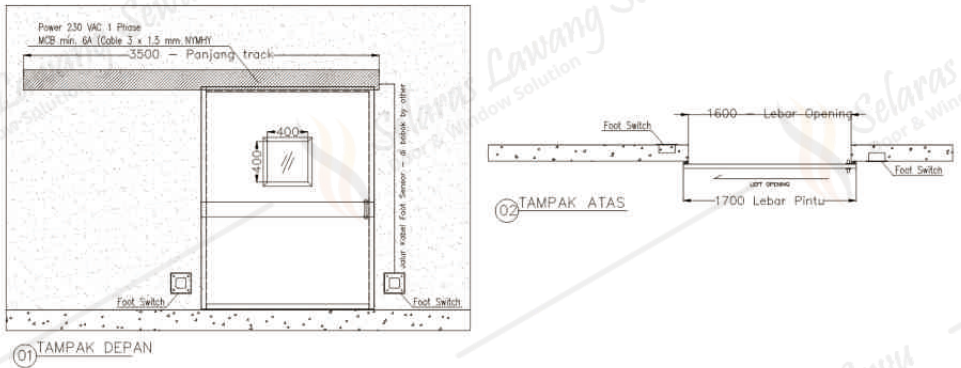

## Interlock System Illustration

A fully programmable system can be set up for 2, 4 and doors.

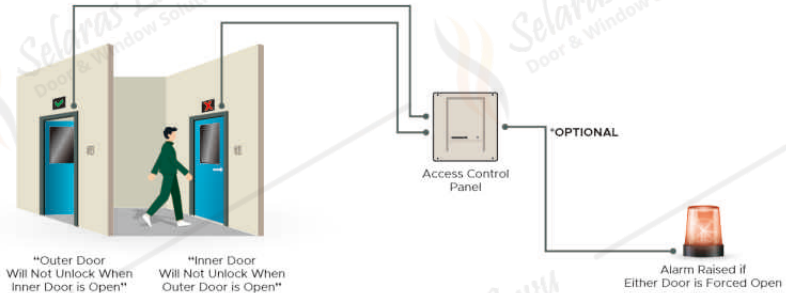

# Modular Operating Theatre Accessories

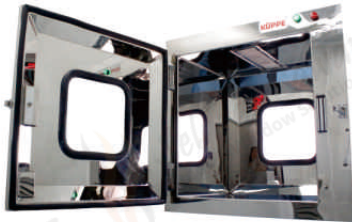

PASSBOX

**HRM KP03 S**

**HRM KP03 SR**  
Lead Passbox

## Specification

• Material	Stainless steel SUS 304 grade
• Outer size	(800x800x500)mm / (600x600x500)mm
• Body construction	SUS 304 thick 1,5mm
• Finishing	Mirror SS & Hairline SS
• Accessories	LED lights 22m diameter, 220VAC
• LED Color	Red & green
• Interlock System	
• Ultraviolet lights (UV)	
• Magnetic interlock	
• Power supply, pilot lamp, switch,	
• relay, hinge handle, seal	
• View glass	5mm x 300mm x 300mm



DISPOSAL

**HRM KP04 S**

**HRM KP04 SR**  
Lead Disposal

## Specification

• Stainless Steel Plate SUS 304 1mm or 1,5mm 4"x8"
• Pull Handle
• Hinge
• Door Closer
• Door Seal
• Foot Sensor
• Electromagnetic Lock
• Power Supply
• Lead (optional)



OPERATING TIMER

**HRM KP05 S**  
32 inch

**HRM KP05 SR**  
42 inch

## Specification

Special time monitoring display:
• Computerized & Mini PC
• Integrated with Humidity & Temperature Sensor
• Can be set using mouse
• There are digital number setting in the date Time, and count down fields
• Display a frame measuring 75 x 60 cm/100 x 75 cm
• Use an average maximum power of 80 watt
• Input voltage of 220 volts AC

**Passbox Illustration**

**600x600x500mm**

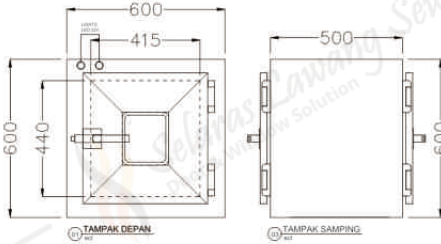

**800x800x500mm**

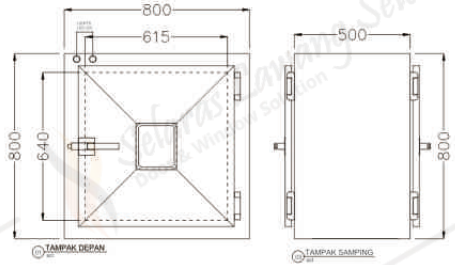

**Disposal Illustration**

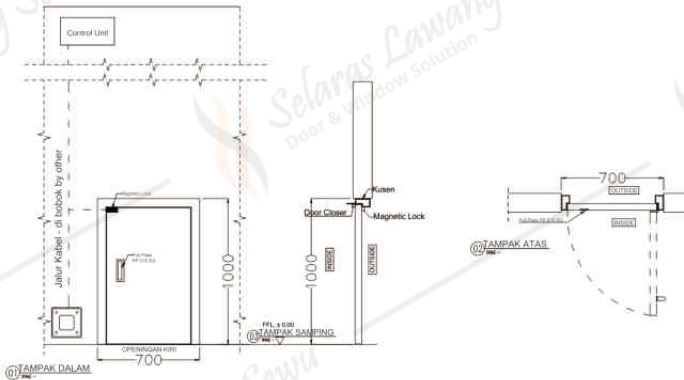

**Operating Timer Illustration**

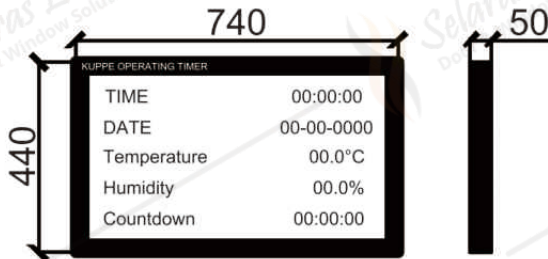

# Modular Operating Theatre Accessories



**X-RAY VIEWER**

**HRM KP06 S**  
Single Film

**HRM KP06 D**  
Double Film

**HRM KP06 T**  
Triple Film

## Specification

- Super energy efficient
- Reduces eye fatigue
- 50,000 hours with maintenance
- Fully adjustable screen on desktop unit
- Super slim at 3cm (9cm less than standard models)
- Integrated film grip
- Conforms with the latest EC regulations
- Chassis manufactured in anti-scratch anodized aluminum



**TOOLS CABINET**

**HRM KP07 S**

Tools storage cabinet made by Stainless steel SUS 304 grade, ease of cleaning and anti rust properties material. By using Tools storage cabinet, it's warranty to keep medical equipments are safe & sterile.

**Size 1200 x 1600 x 400**

## Specification

- Body made by stainless steel SUS 304 grade
- Frame made by stainless steel SUS 304 grade
- 2-4 shelves glasses (Adjustable High)



**MEDICAL CABINET**

**HRM KP08 S**

Medical storage cabinet made by Stainless steel SUS 304 grade, ease of cleaning and anti rust properties material. By using Medical storage cabinet, it's warranty to keep medical equipments are safe & sterile.

**Size 1200 x 1600 x 400**

## Specification

- Body made by stainless steel SUS 304 grade
- Frame made by stainless steel SUS 304 grade
- 2-4 shelves glasses (Adjustable High)

### X-Ray Viewer Illustration

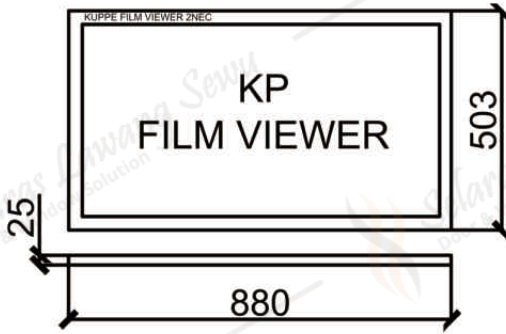

### Tools Cabinet Illustration

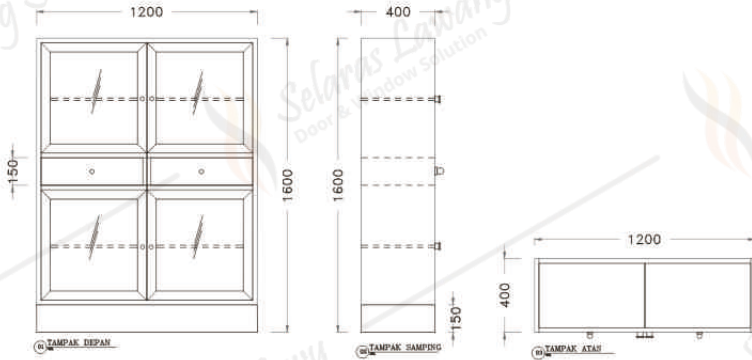

### Medical Cabinet Illustration

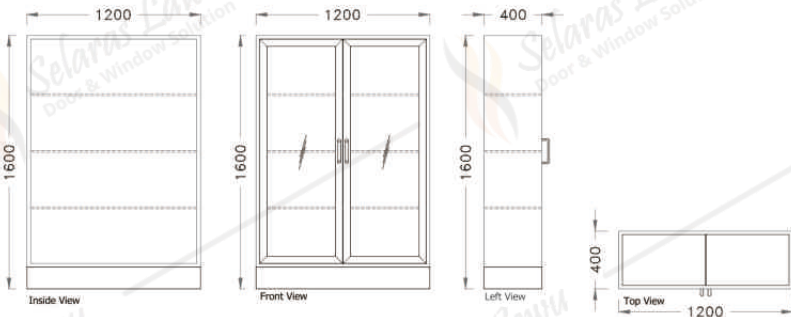

## Modular Operating Theatre Accessories



COOLER & WARMER CABINET

**HRM KP09 S**  
Cooler Cabinet

**HRM KP10 S**  
Warmer Cabinet

Cooler & Warmer Cabinet is a cupboard for cold and warm temperature storage to maintain sterilization.



POWER GROUND MODULE

**HRM KP11 S**

### Specification

- Power : Single 16A, 230 V, 2P, 3W  
Ground lock type
- Ground
- Enclosure : 1.6mm THK

Galvanized steel box with 1.2mm THK backed SCHNELL finished or stainless steel 304 cover.



MEDICAL GAS OUTLET

**HRM KP12 S**

Medical Gas Outlet is an operating room component, the functions is to distribute medical gas.



# Modular Operating Theatre Accessories

**LIGHTING BOX****HRM KP13 S**

## Specification

Welded steel structure, white epoxy coat finish (close to RAL9010)

- IP65 rated on lower side and IP64 rated on upper side
- High frequency control gear
- Detachable gear tray
- Lamps LED for energy saving
- TP(a) rated diffusers
- Anti-bacterial coating

**WRITING TABLE****HRM KP14 S**

It is a writing desk in the Operating Theatre for the doctor to record the results of observations during surgery.

**CONTROL PANEL**

**HRM KP15 S**  
Manual System

**HRM KP16 S**  
Touch Screen System

One of the components that integrated with the operating room. There is also a Control panel with a Touch Screen System.

# Modular Operating Theatre Accessories

## Pendant Manual System

**HRM KP21 S** HRM KP23 S  
Surgery Anesthesia



**SINGLE FIXED ARM PENDANT  
SF SERIES**

**HRM KP21 D** HRM KP23 D  
Surgery Anesthesia



**DOUBLE FIXED ARM PENDANT  
DF SERIES**

**HRM KP19 D**



**ICU TWIN PENDANT  
DUO SERIES**

## Pendant Motorized System

**HRM KP22 S** HRM KP24 S  
Surgery Anesthesia



**SINGLE RETRACTABLE  
MOTORIZED ARM PENDANT  
SM SERIES**

**HRM KP22 D** HRM KP24 D  
Surgery Anesthesia



**DOUBLE RETRACTABLE  
MOTORIZED ARM PENDANT  
DM SERIES**

**HRM KP20 D**



**ICU RETRACTABLE  
MOTORIZED ARM PENDANT  
SM SERIES**

## Specification

		SF Series	DF Series	SM Series	DM Series
<b>Arm Length</b>		600mm	1200mm (600+600mm)	1000mm	1600mm (600+1000mm)
		864mm	1464mm (864+600mm)	-	1864mm (864+1000mm)
		1130mm	1728mm (864+864mm)	-	2130mm (1130+1000mm)
		-	1994mm (1130+864mm)	-	-
<b>Rotation</b>	Ceiling Joint	330°	330°	330°	330°
	Middle Joint	-	330°	-	330°
	Head Joint	340°	340°	340°	340°
	Ceiling Joint	Air	Air	Air	Air
<b>Brakes</b>	Middle Joint	-	Air	-	Air
	Head Joint	Friction	Friction	Friction	Friction
	Hi-Lo	-	-	610mm	610mm
<b>Ceiling Height</b>		2600-3700mm	2600-3700mm	2600-3700mm	2600-3700mm
	<b>Net Payload</b>	With a 500mm Head 160Kg With a 750mm Head 140Kg With a 1000mm Head 120Kg	140Kg 120Kg 100Kg	120Kg 100kg -	120Kg 100Kg -

# Modular Operating Theatre Accessories

**OPERATING LAMP****HRM KP29**

## Specification

• Illuminance	≥140.000/≥120.000 Lux Colour
• Illuminance Depth	≥1300mm <sup>2</sup>
• Size of Light Field	160-280mm
• Power Supply Voltage	AC110-240V, 50/60Hz
• Brightness Adjustment	Automatic - Stage Continuous Light Adjustment
• Lowest height of installation	2900mm
• Total Power Consumption	140W
• Total LED Bulb Quantity	180 Pcs (18*6+12*6)

**OPERATING TABLE****HRM KP30**

Electric operating table is used for general surgery, heart & kidney orthopedics, neurosurgery, gynecology, urology and other surgical. Driven by Low Voltage DC Motor with advance backup power, safe and reliable.

The leg board can open and is removable. The base cover is made of stainless steel, slushing and easy to clean.

- **Lenght : 2020mm**
- **Width : 500mm**
- **Min Height : 550mm**
- **Max Height : 800mm**

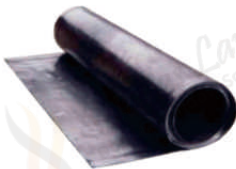
**LEAD SHEET**

Lead Sheet is used as a protective or coating on the radiology room in the hospital. This product is made from pure tin level close to 100% so it has perfect radiation resistance.

**Thickness :**  
**2mm & 3mm**

# Modular Operating Theatre Accessories



**LEAD GLASS**

**HRM KP35**  
Lead 15mm

**HRM KP36**  
Lead 20mm

Doors and radiology / operator station must use specially lead coated glass. With the recommended thickness of lead.

## Specification

Lead Glass size:	
• Door	: 400 x 400mm
• Operator Room	: A. 800 x 800mm B. 1000 x 1000mm C. 1000 x 1200mm D. Customize



**RETURN GRILL**

**HRM KP31**

A Return air grill is an essential part of any HVAC system. A return air grill connects to ductwork that allows air to return to any cooling or heating system. The openings that connect to ducts and other spaces for the returning air are normally with grillwork.



**SCRUBSINK**

**HRM KP18 S**  
One Station

**HRM KP18 D**  
Two Station

**HRM KP18 T**  
Three Station

## Specification

- Stainless steel SUS 304
- High quality material and finished
- Available in 1, 2 and 3 washing station
- Power supply : 220 vac. 1000 watt
- UV Sterilization with selector for warm or cool water
- Water filter 1 micron

### Scrubsink Illustration

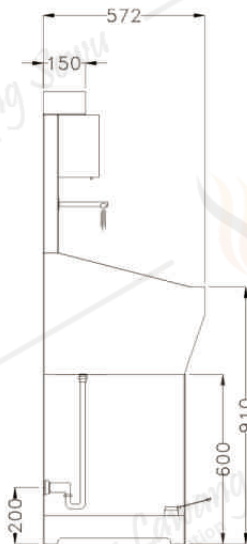

03 TAMPAK SAMPIING  
BOL

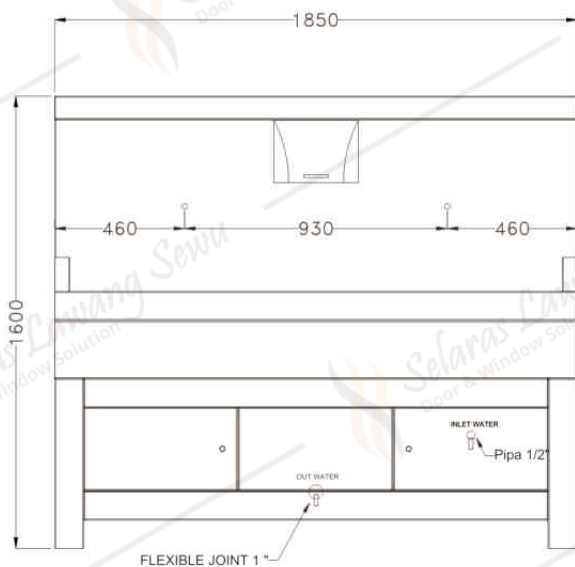

01 TAMPAK DEPAN  
BOL

# Steel & Aluminium Door (900x2150mm)

**AMK 2610 S**  
Steel Solid

**AMK 2615 S**  
Aluminium Solid

**AMK 2611 S**  
Steel  
Short View

**AMK 2616 S**  
Aluminium  
Short View

**AMK 2612 S**  
Steel  
Long View

**AMK 2617 S**  
Aluminium  
Long View

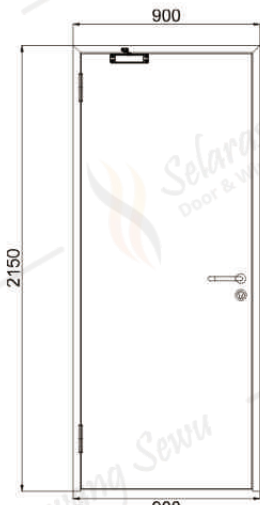

01 TAMPAK DEPAN

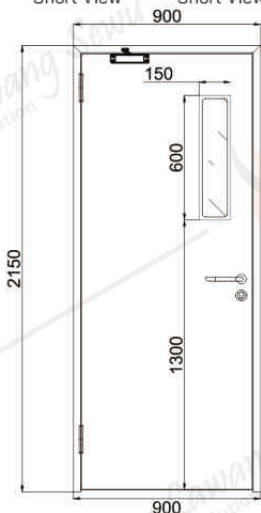

01 TAMPAK DEPAN

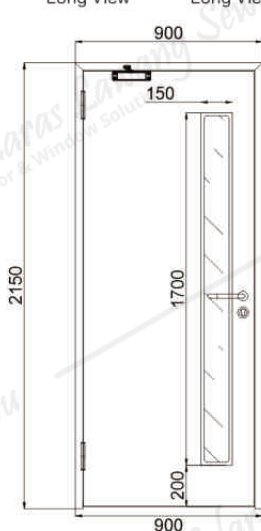

01 TAMPAK DEPAN

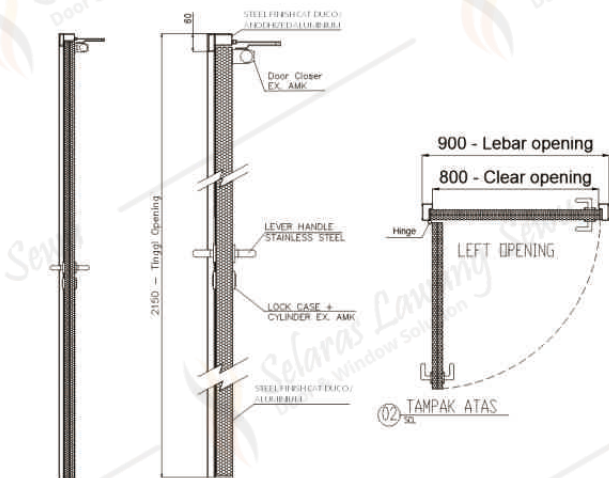
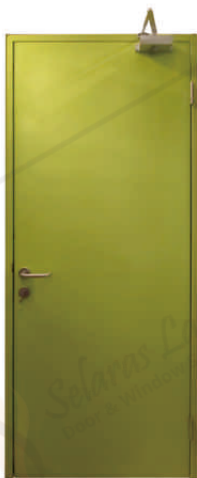

01 TAMPAK SAMPIING

**Amk**  
Color Option



# Steel & Aluminium Door (900x2150mm)

**AMK 2613 S**  
Steel Solid +  
Relief Damper

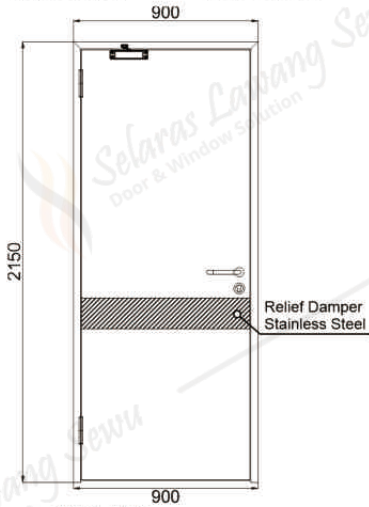

01 TAMPAK DEPAN

**AMK 2618 S**  
Aluminium Solid +  
Relief Damper

**AMK 2614 S**  
Steel Short View +  
Relief Damper

**AMK 2619 S**  
Aluminium Short view +  
Relief Damper

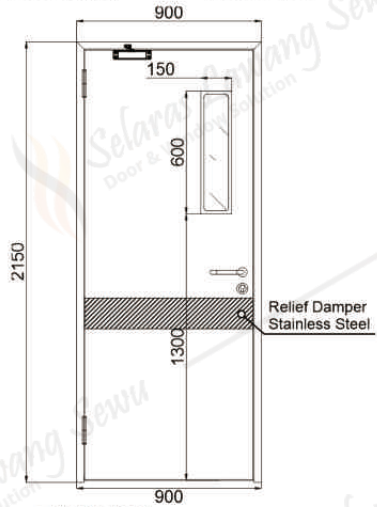

01 TAMPAK DEPAN



01 TAMPAK SAMPING

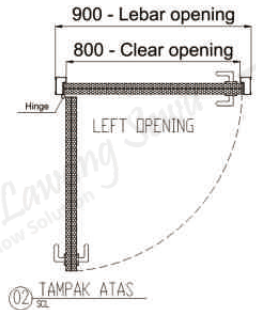
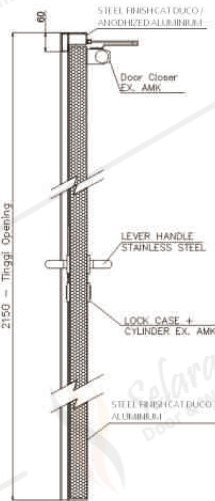

**Amk**  
Color Option



# Steel & Aluminium Door (1200x2150mm)

**AMK 2621 D** Steel Short View  
**AMK 2626 D** Aluminium Short View

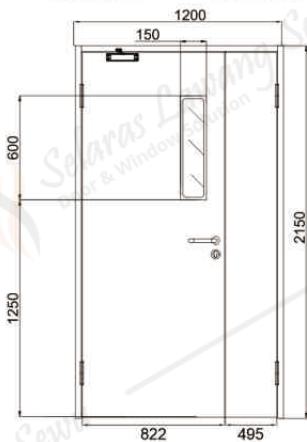

01 TAMPAK DEPAN

**AMK 2622 D** Steel Long View  
**AMK 2627 D** Aluminium Long View

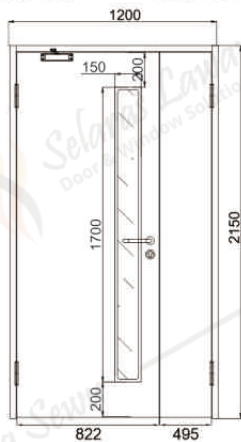

01 TAMPAK DEPAN

**AMK 2624 D** Steel Short View + Relief Damper

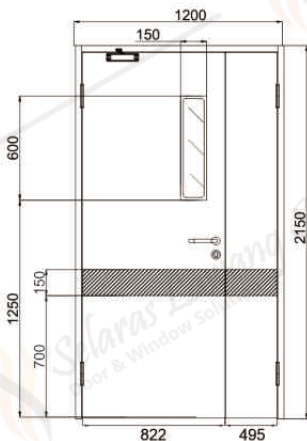

**AMK 2629 D** Aluminium Short View + Relief Damper

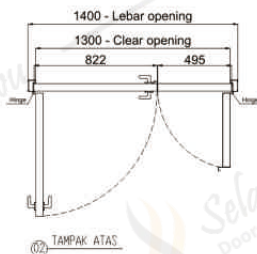

02 TAMPAK ATAS

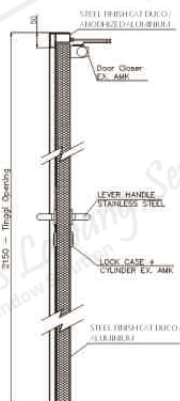

**Amk**  
Color Option





# Steel & Aluminium Door (1400x2150mm)

**AMK 2621 D**  
Steel  
Short View

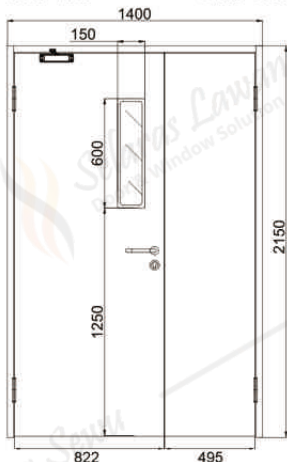

01 TAMPAK DEPAN

**AMK 2626 D**  
Aluminium  
Short View

**AMK 2622 D**  
Steel  
Long View

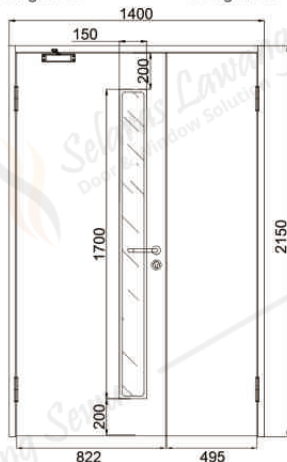

01 TAMPAK DEPAN

**AMK 2627 D**  
Aluminium  
Long View

**AMK 2624 D**  
Steel Short View +  
Relief Damper

**AMK 2629 D**  
Aluminium Short View +  
Relief Damper

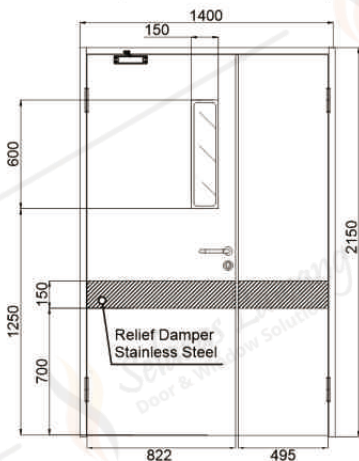

01 TAMPAK DEPAN

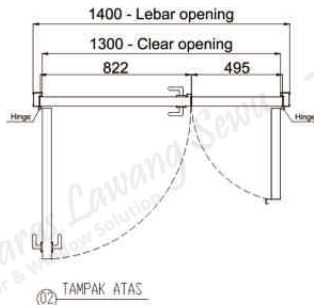
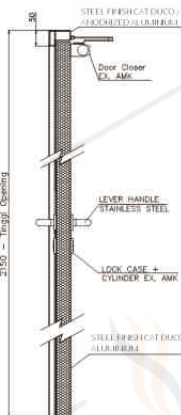

02 TAMPAK ATAS

**Amk**  
Color Option



# AMK Double Door



## Aluminium Door (900x2150mm)

AMK 2631 S  
Aluminium

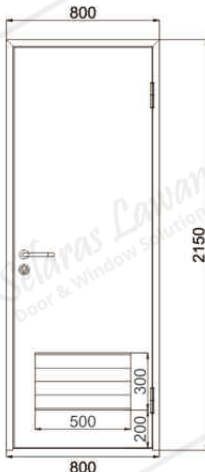

01 TAMPAK DEPAN

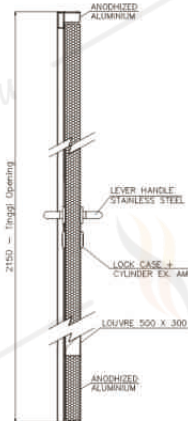



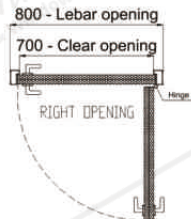
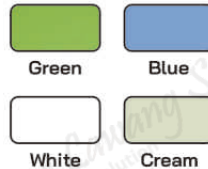





### AMK Color Option



02 TAMPAK ATAS

# AMK Specification

No	Accessories	Picture
1	<b>Door Leaf</b> : Steel 0.7mm Plate / Aluminium 1.2mm Plate	-
2	<b>Door Frame</b> : Steel 1mm Plate / Galvanis 1mm Plate	-
3	<b>Door Leaf</b> : Aluminium 0.8mm Plate	-
4	<b>Door Frame</b> : Aluminium 1mm Plate	-
5	Expandable Polystyrene (EPS) Density (M) 1000x2000mm	-
6	Handle LHTR 016 19mm SUS 304 - AMK	
7	Door Closer DCL 202 NHO NA - AMK	
8	Mortise Lock MTS IL 5085 SUS 304 - AMK	
9	Cylinder CYL DC 65mm SN - AMK	
10	Hinge ESDL 304 4x3x2,5mm 2BB Satin Stainless Steel - AMK	
11	Escutcheon DKS ESCN 855 Satin Stainless Steel(F0413)	
12	Flush Bolt DKS FB SQ 501-270mm	
13	Door Seal DKS "D" Profile DSD 9x6mm	
14	Double Clear Glass Non Tempered 6mm (size 150x600mm / 150x700mm)	-
15	Louvre Aluminium 500x300mm For Toilet Door	-

## Automatic Sliding



AMK SLIDING AUTOMATIC

**AMK 1033 S**  
Single Door

**AMK 1033 D**  
Double Door

Door Leaf	Single Leaf	Double Leaf
Weight of door leaf	Max. 150 kg	Max. 2x 120 kg
Width of door leaf	DW + 750 - 1600mm	DW + 650 - 1050mm
Width of door opening	W = Max. 1550mm	W = Max. 2000mm
Method of installation	Surface installation	
Supply power voltage	AC 110 - 2200V $\pm$ 10%, 50/60 Hz	
Opening speed	150 - 460mm/s (adjustable)	
Closing speed	130 - 460mm/s (adjustable)	
Door hold-open time	0 - 8s (adjustable)	
Manual open/close force		
Motor	DC 24 V, 60 - 70W (DC, brushless)	
Working environment temperature	-20°C ~ 50°C	

# AMK Automatic Illustration

## Single Door

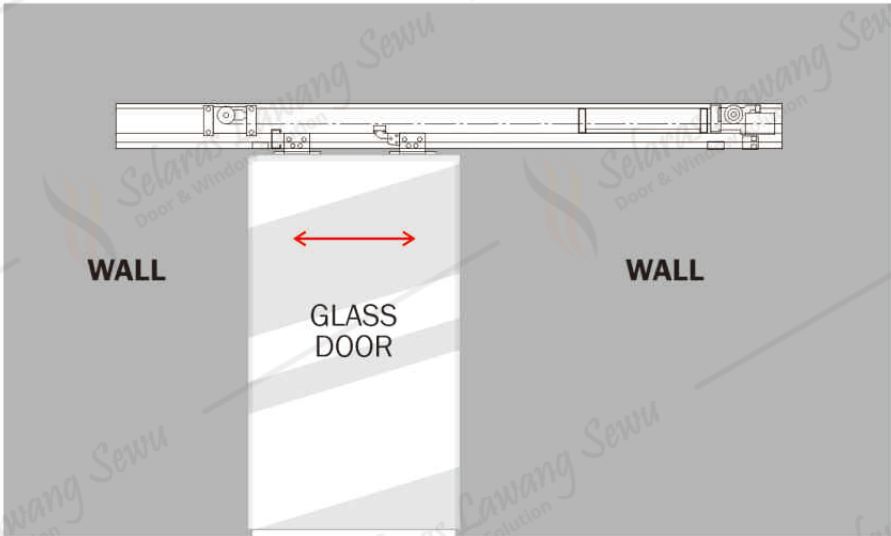

## Double Door

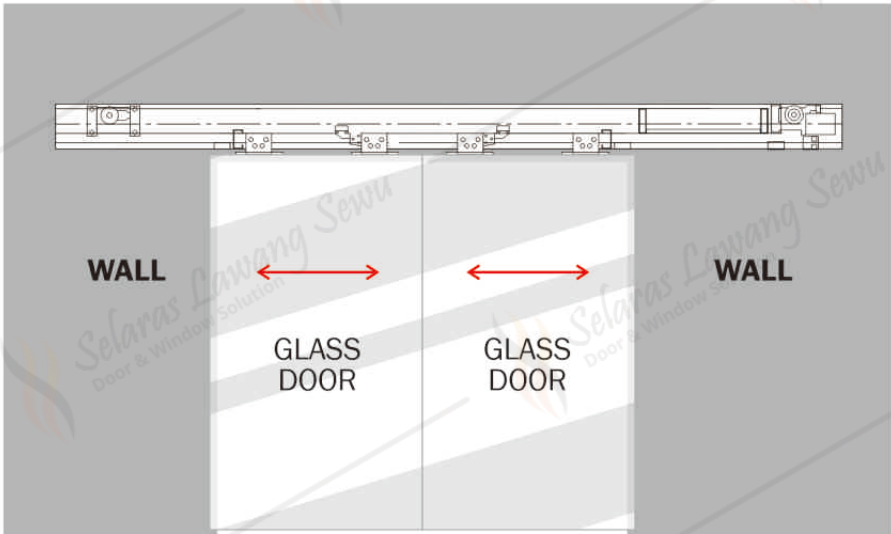

# Manual Folding & Variotec Door



**MANUAL FOLDING DOOR**

## FD PM GLASS

### Technical Data

1	Max door width	1250mm
2	Max door weight	250kg/pair
3	Max door height	3500mm
4	Glass thickness	12mm
5	Material	Aluminium
6	Cover furniture	Aluminium anodized Wood coating color (optional) Stainless steel (optional)
7	Roller	Stainless steel with 4 Horizontal Nylon, 4 Vertical nylon
8	Bottom rail	Can be use with/without U-Channel

### Optional Door Installation

**End Fold**

**Center Fold**



**MANUAL VARIOTEC DOOR**

## VARIOTEC PM GLASS

## VARIOTEC PM WOOD

### Technical Data

1	Max door width	1250mm
2	Max door weight	200kg/pair
3	Max door height	3500mm
4	Glass thickness	12mm
5	Material	Aluminium
6	Cover furniture	Aluminium anodized Wood coating color (optional) Stainless steel (optional)
7	Roller	Stainless steel with 4 Horizontal Nylon, 4 Vertical nylon
8	Bottom rail	Clean, without bottom rail (without U-Channel)

**Plan View of Parking Bay**

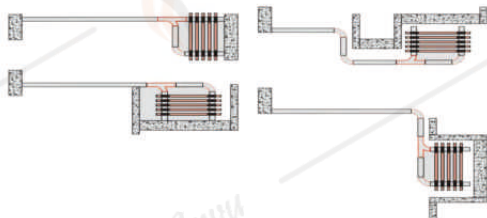

**P&M Folding Door illustration**

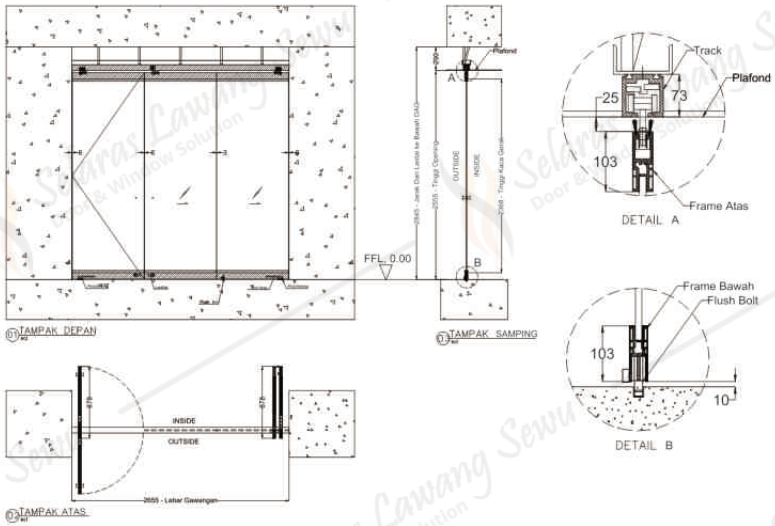

**P&M Variotec illustration**

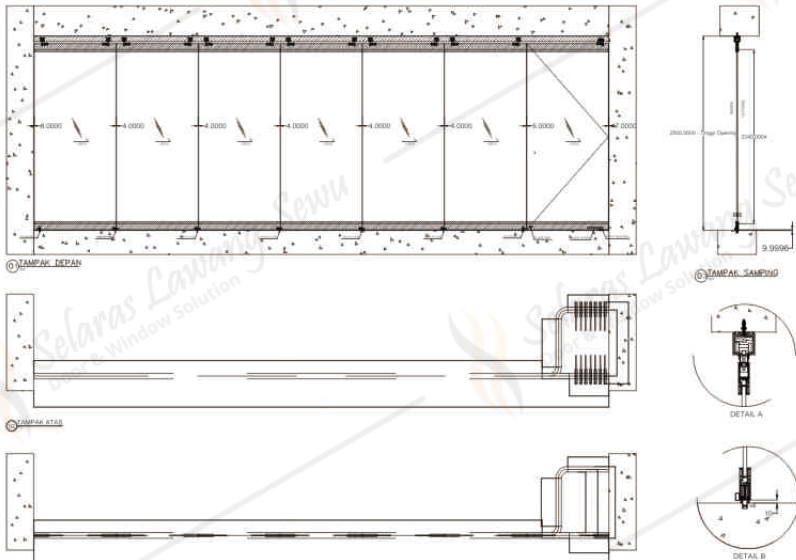

# Manual Sliding Door

## PM SF16 SL



### Components for glass door

1	Aluminium top track	1.8m
2	Wall mount bracket	3 pcs
3	Nylon carriage roller	2 pcs
4	Nylon floor guide	1 pcs
5	Aluminium glass clamp	2 pcs
6	End stopper with catch device	2 pcs
7	Hanger glass	2 pcs

### Components for wooden door

1	Aluminium top track	1.8m
2	Wall mount bracket	3 pcs
3	Nylon carriage roller	2 pcs
4	Nylon floor guide	1 pcs
5	End stopper with catch device	2 pcs
6	Hanging strap	2 pcs

Max door weight : 45kg | Max door width : 900mm | Max door height : 2000mm | Max glass thickness : 10mm

## PM SF23 SL



### Components for glass door

1	Aluminium top track	2.5m
2	Wall mount bracket	5 pcs
3	Stainless steel carriage roller	2 pcs
4	Glass patch	2 pcs
5	Nylon floor guide	1 pcs
6	End stopper with catch device	2 pcs

### Components for wooden door

1	Aluminium top track	2.5m
2	Wall mount bracket	5 pcs
3	Nylon carriage roller	2 pcs
4	Hanging strap	2 pcs
5	Nylon floor guide	1 pcs
6	End stopper with catch device	2 pcs

Max door weight : 130kg | Max door width : 1200mm | Max door height : 3000mm | Max glass thickness : 12mm

## PM SF40 SL



### Components

1	Aluminium top track	1 length x 1.5m
2	Stainless steel mounting bracket	1 set
3	Compro mising 1pc left hand & 1pc right hand	1 set
4	Ø35 knob clamp stainless steel roller	2 nos
5	Nylon end stopper with catch device	2 nos
6	Nylon single-U adjustable floor guide (optional components)	1 nos
7	KH20 round recess door knob	
8	XGM89 snap-on aluminium track cover	
9	XGM91 aluminium bottom channel	
10	XGM90 aluminium channel cover	
11	Vinyl clip seal	

Max door weight : 50kg

## PM SF50 SL

## PM SF50 TL



### Components for glass door

1	Aluminium top track	2.5m
2	Wall mount bracket	5 pcs
3	Stainless steel carriage roller	2 pcs
4	Glass patch	
5	Nylon floor guide	1 pcs
6	End stopper with catch device	2 pcs

### Components for wooden door

1	Aluminium top track	2.5m
2	Wall mount bracket	5 pcs
3	Nylon carriage roller	2 pcs
4	Hanging strap	2 pcs
5	Nylon floor guide	1 pcs
6	End stopper with catch device	2 pcs

Max door weight : 250kg | Max door width : 1200mm | Max door height : 3000mm | Max glass thickness : 12mm



# Manual Sliding Door

## PM SF51 SL



### Components

1	SF51 (tr) Aluminium track	
2	SF51 (CR3) - Three wheels carriage rollers clamp	2 nos
3	SF51 (FC) - Flip on aluminium cover	
4	SF51 (ES) - End stopper with catch device (LH/RH)	2 nos
5	SF51 (EC) End Cap (LH/RH)	2 nos
6	UG-S01ADJ single-U stainless steel floor guide	1 nos

Max door weight : 150kg

## PM SF500

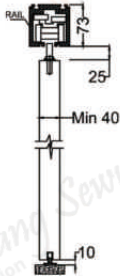

### Components for glass door

1	Aluminium top track 9910
2	Roller RLV 400 + Slider
3	Upper main frame
4	Variotec cover frame
5	Variotec end cover 100 NA
6	Bracket elbow 5x5
7	Stopper variotec
8	Floor Guide glass
9	Gasket variotec 100

### Components for wooden door

+ Hanger
+ Nylon for guide
+ U channel

Weight capacity : 500kg

## SELF CLOSER PM



### Components

1	Main top track end	6	Control rack gear
2	Hanger with roller	7	Hydraulic latch control device
3	Anti-jump screw	8	Pull spring closing control device
4	Glass clamp	9	End stopper
5	Catch device	10	Nylon floor guide

# Sliding Door Accessories



**HDL 01**  
Round Handle



**HDL 02**  
Rectangular Handle



**HDL 03**  
Handle + Lock for Swing



**HDL 04 & Strike Box**  
Handle + Lock for Sliding



**HDL 06**  
Knob Handle



**HSB 01S/D**  
Strike box for handle &  
Lock Swing



**Lockset**  
Lockset



**LSB 01**  
Strike Box  
for Sliding



**LCS 01**  
Sliding Lock



**RLV 500**  
Variotec Roller



**RLV 400**  
Variotec Roller

# Sliding Door Illustration

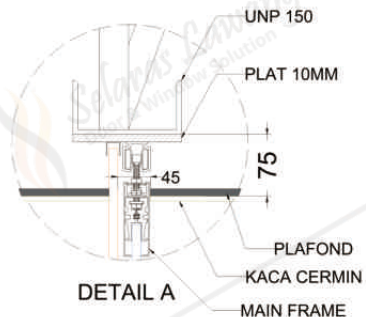
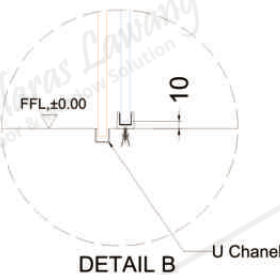
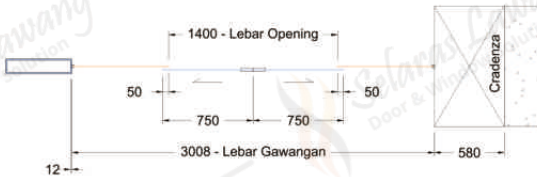
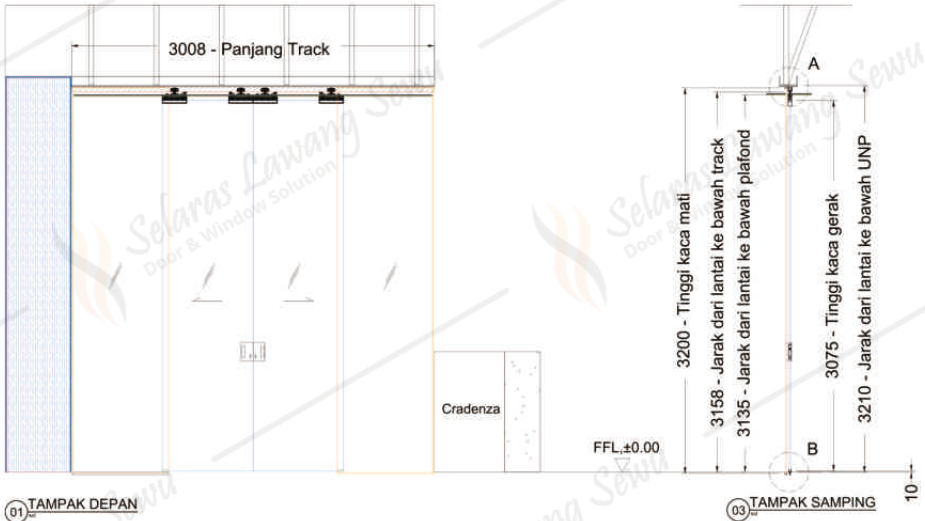

# Sliding Telescopic Illustration

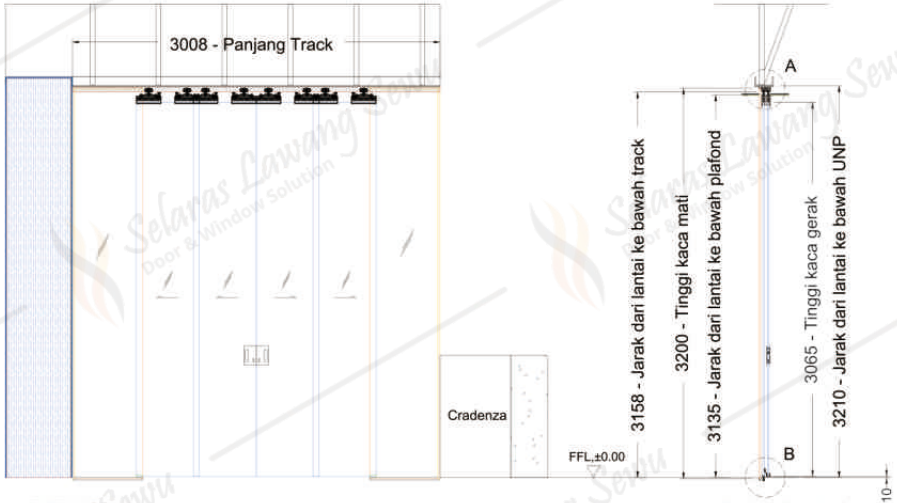

01 TAMPAK DEPAN

03 TAMPAK SAMPIING

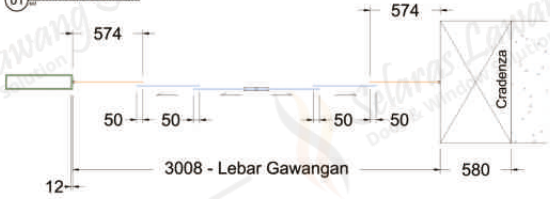

02 TAMPAK ATAS

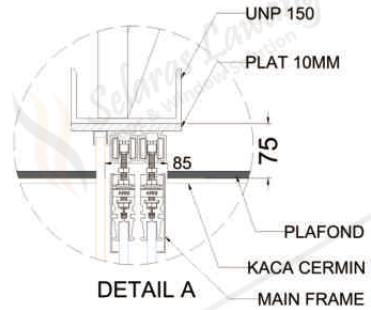
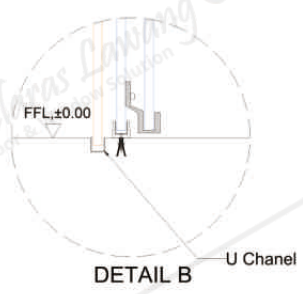

# Sliding Magtec

## MAGTEC PM GLASS



MAGTEC GLASS SYSTEM

### Specification

- Stainless Steel Track
- Bracket
- Roller
- Stopper
- End Cap
- Floor Guide Stainless Steel
- Handle

### Sliding Magtec illustration

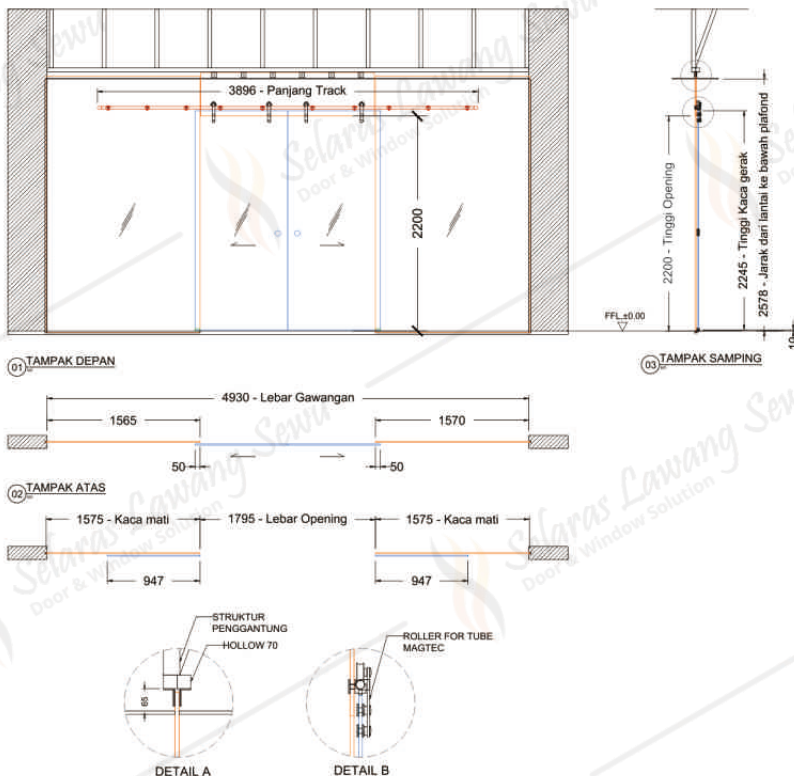

# Shower Cubical

CT DKS PH01



SHOWER CUBICAL PHENOLIC

### Specification

- Door and wall phenolic limits 12mm
- HPL material in press resin
- Head Rail
- U profile
- Door Stopper
- Aluminium Corner
- High standard including feet : 200cm

CT DKS GL01



SHOWER CUBICAL CERAMICS

### Specification

- Glass 10mm tempered with :
  - a. Ceramics
  - b. Laminated
  - c. Sandblast
  - d. Glass film (bad/white)
- Hinge
- Foot Partition
- Stang Pipe
- Stainless Steel
- Glass Clip G/G 90 : Stainless steel 304 (round)
- Cubical 10 – 15cm

### Shower Cubical illustration

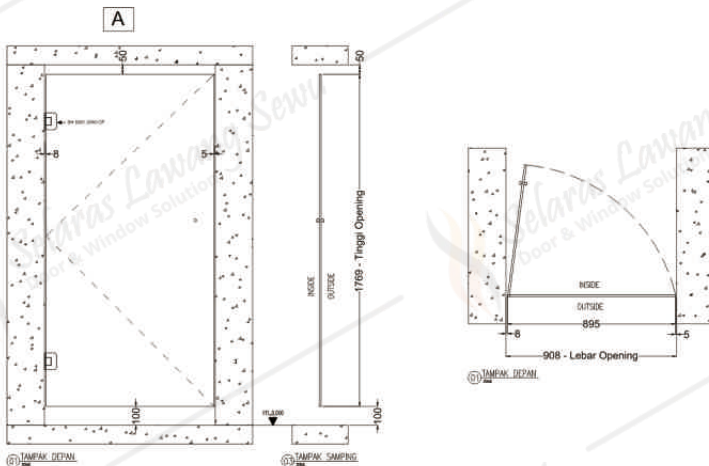

# Linac Door

HRM 1840 SR



LINAC DOOR

## Specification

GBD Automatic Drive Capacity 2500kg	1 Unit
Stainless Steel Door Panel 1,5mm thickness, with lead 4mm + BPE 50mm + lead 4mm	1 Unit
Safety Beam Sensor	1 Unit
Rack 2m	1 Unit
Foot Switch	2 Pcs
Monorail System 2000Kg with Manual Trolley	1 Unit
Bracket	1 Unit
Machine Cover Stainless Steel SUS 304	1 Unit
Stainless Steel Emergency Handle Inside & Outside	1 Unit

## GBD Linac illustration

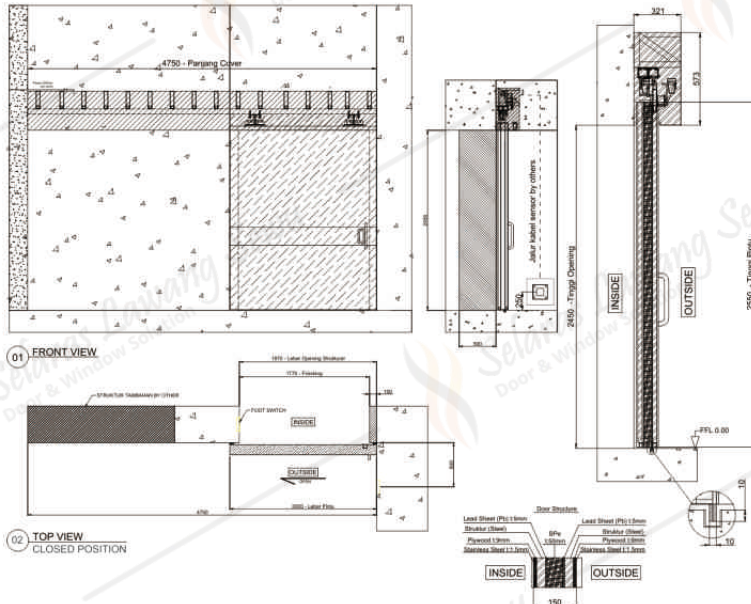

# Brachytherapy Door

**HRM 1840 BR**  
GBD Drive

**HRM 24X3 BR**  
TORMAX Drive

## Specification

GBD / TORMAX Automatic Drive Capacity 2500kg	1 Unit
Stainless Steel Door Panel 1.5mm thickness, with lead 5mm	1 Unit
Safety Beam Sensor	1 Unit
Rack 5m	1 Unit
Foot Switch	2 Pcs
Monorail System SWL 2000Kg with Manual Trolley	1 Unit
Bracket & Machine Mount	1 Unit
Machine Cover Stainless Steel SUS 304	1 Unit
4 Sides seal for air pressure unit	1 Unit
Stainless steel emergency handle inside & outside	2 Pcs

## Brachytherapy illustration

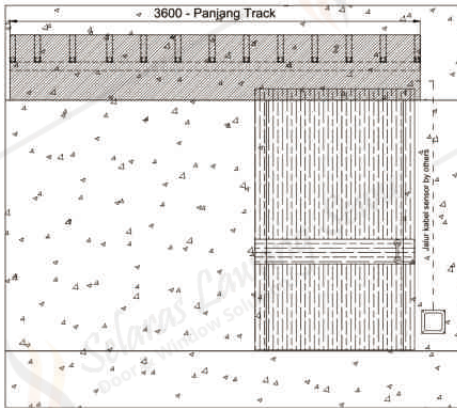

01 TAMPAK DEPAN



03 TAMPAK ATAS

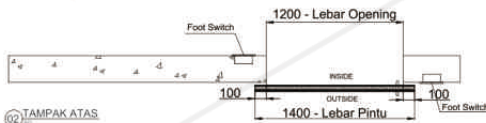
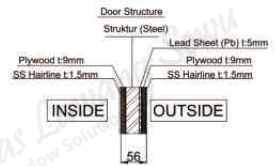

02 TAMPAK ATAS

# Automatic Sliding Gate

SL 544



SL TYPE

## Specification

• Power Supply	230 Vac-50/60 Hz
• Power Consumption	100W
• Protection Class	Ip55
• Speed	200 mm/s
• Leaf Weight	500kg
• Ambient Temperature	-20°C +60°C
• Force Regulation	Electronic
• Safety Standard	Safety and Force sensor

PASS 840 E



PASS TYPE

## Specification

• Power Supply	230 Vac-50/60 Hz
• Power Consumption	300W
• Protection Class	Ip55
• Speed	147 mm/s
• Leaf Weight	800kg
• Ambient Temperature	-20°C +60°C
• Force Regulation	Electronic
• Safety Standard	Safety and Force sensor

PASS 1840

PASS 2500



PASS TYPE

## Specification

• Power Supply	230 Vac-50/60 Hz ( <b>PASS 1800</b> ) & 380Vac ( <b>PASS 2500</b> )
• Power Consumption	700W ( <b>PASS 1800</b> ) & 750W ( <b>PASS 2500</b> )
• Protection Class	Ip55
• Speed	147 mm/s
• Leaf Weight	1800kg & 2500kg
• Ambient Temperature	-20°C +60°C
• Force Regulation	Electronic & Mechanical ( <b>PASS 2500 mechanical only</b> )
• Safety Standard	Safety and Force sensor

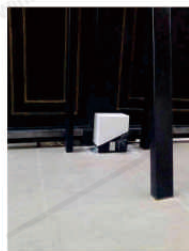



**SL 544**  
**Illustration**

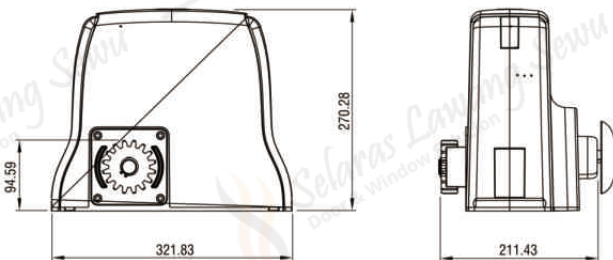

**PASS 840 E**  
**Illustration**

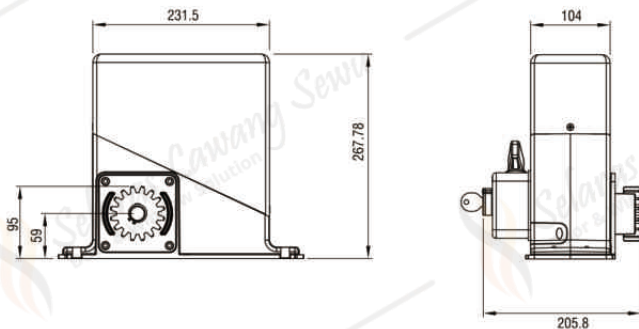

**PASS 1840 & 2500**  
**Illustration**

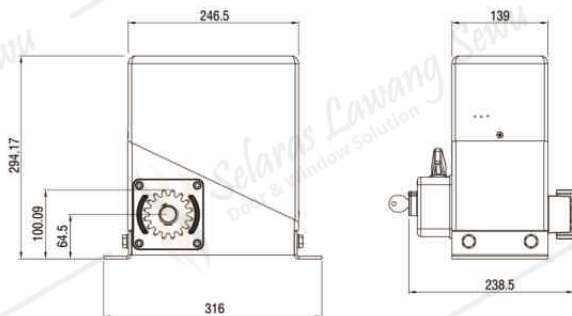

# Automatic Swing Gate

**TOP 291**

**TOP 441**



**TOP TYPE**

• Power Supply	230 Vac-50/60 Hz
• Power Consumption	170W ( <b>TOP 291</b> ) & 190W ( <b>TOP 441</b> )
• Protection Class	Ip65
• Rod Speed	20 mm/s
• Max Door Weight	350kg ( <b>TOP 291</b> ) & 600kg ( <b>TOP 441</b> )
• Ambient Temperature	-20°C +60 °C
• Force Regulation	Hydraulic
• Rod Length	290 ( <b>TOP 291</b> ) & 440 ( <b>TOP 441</b> )
• Max Leaf Length	3,5m ( <b>TOP 291</b> ) & 6m ( <b>TOP 441</b> )

**ART 5024**



**ART TYPE**

## Specification

• Power Supply	230 Vac-50/60 Hz
• Power Consumption	100 W
• Protection Class	Ip53
• Speed	7,8°/s
• Max Door Weight	350 kg
• Ambient Temperature	-20°C +60 °C
• Force Regulation	Electronic
• Max Leaf Length	3 m

**KUDA 240**



**KUDA TYPE**

## Specification

• Power Supply	230 Vac-50/60 Hz
• Power Consumption	100 W
• Protection Class	Ip44
• Rod Speed	200 mm/s
• Max Door Weight	200 kg
• Ambient Temperature	-20°C +60 °C
• Force Regulation	Electronic
• Rod Length	360
• Max Leaf Length	2 m

**FLOOR 824**



**FLOOR TYPE**

## Specification

• Power Supply	230 Vac-50/60 Hz
• Power Consumption	120 W
• Protection Class	Ip67
• Speed	7°/s
• Max Leaf Length	3 m
• Ambient Temperature	-20°C +60 °C
• Force Regulation	Electronic
• Max Door Weight	600 kg
• Max Leaf Rotation	180°

### TOP 291 & 441 Illustration

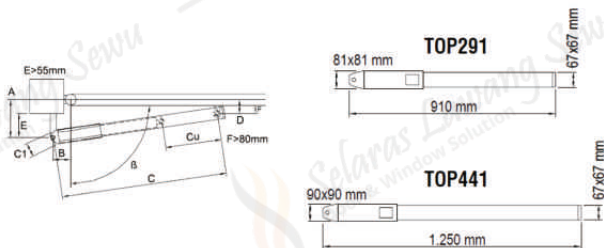

### SRT 5024 Illustration

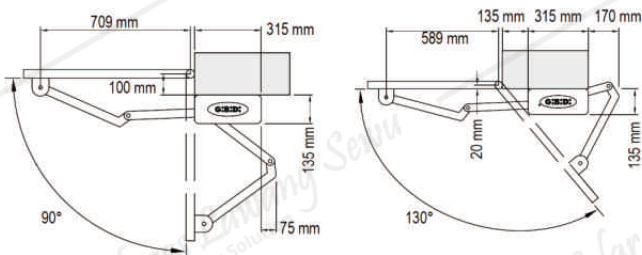

### KUDA 240 Illustration

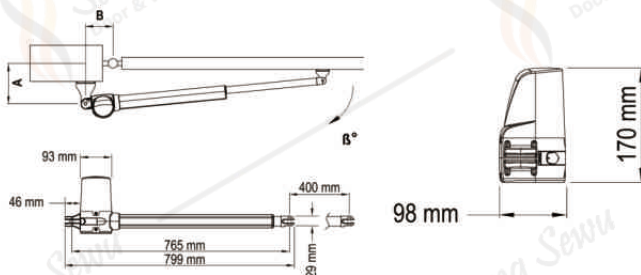

### FLOOR 824 Illustration

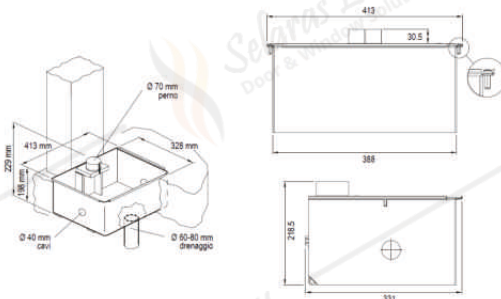

## Automatic Barrier

500 STD 500 CPT



SL TYPE

### Specification

• Power Supply	230 Vac-50/60 Hz
• Power Consumption	150 W
• Protection Class	Ip55
• Opening Speed	5 s (1,8 s)
• Anti Crushing	Yes
• Ambient Temperature	-20 °C +60 °C
• Force Regulation	Electronic
• Balancing Spring	Pushing Spring

## Automatic Bollard

BOLLARD 200



BOLLARD

### Specification

• Power Supply	230 Vac-50/60 Hz
• Power Consumption	600 W
• Protection Class	Ip67
• Opening Time	10 s with single control unit
• Closing Time	15 s with single control unit
• Ambient Temperature	-20 °C +60 °C
• Force Regulation	Electronic
• Operator Weight	340 kg
• Cylinder Stroke	700 mm
• Cylinder Thickness	10 mm
• Resistance Without Deformation	1300 J

## Automatic Garage

T 12



AUTOMATIC GARAGE

### Specification

• Power Supply	230 Vac
• Power Consumption	140 W
• Protection Class	Ip20
• Speed	90 - 125 mm/s
• Ambient Temperature	-20 °C +60 °C
• Force Regulation	Electronic
• Max Door Surface	10 m
• Max Door Height	2.4 m²
• Max Thrust	1200 N

**G:B:D:**  
Door & Window Solution

## Accessories



Remote Control



Flash Light



Safety Beam



Aluminium Post



Transponder



Electric Lock



Backup Battery



Key Selector

## BARRIER 500 STD & CPT Illustration

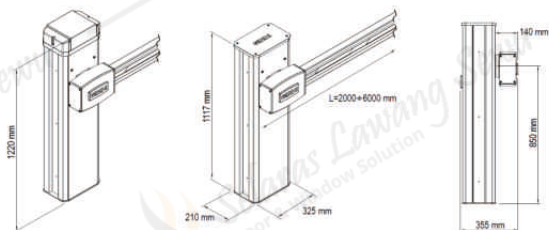

## BOLLARD 200 Illustration

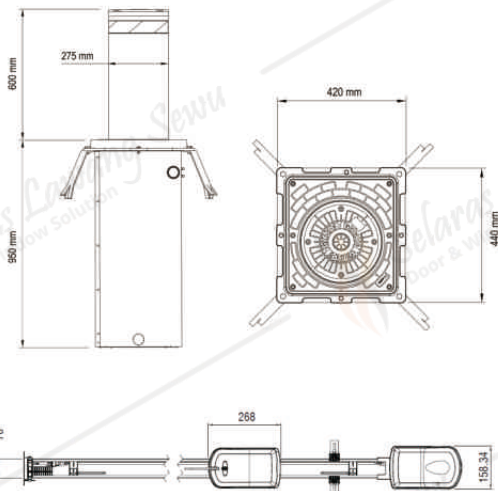

## T12 Illustration

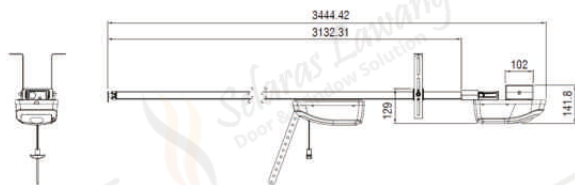

# Project References

## OFFICE, GOVERNMENT OFFICE, MALL & SHOP, HOTEL & PUBLIC TRANSPORTATION

### OFFICE

Astra International - Jakarta  
Gedung Garuda Indonesia - Jakarta  
PT Sanken - Tangerang  
The Newtown - Jakarta  
Honda Autoland - Jakarta  
Pabrik Andin Kim - Karawang  
Office ONE Jasa Marga - Jakarta  
Bank Mandiri Syariah Hasannudin - Jakarta  
Uniair Cargo - Jakarta  
Gd. Kantor Kalimantan  
Jiep Financial Center  
Graha Mm 2100  
Multivision Tower - Jakarta  
Pt. Pak Peter Martimbang  
Garawangi Majalengka - Majalengka  
Soho Pt. Wow - Jakarta  
Northstar - Jakarta  
Pabrik Kusuka - Bogor  
Multivision Tower - Jakarta  
Telkom Experience  
Xg Gandaria  
Sinar Mas MSIG Tower - Jakarta  
Badan Pusat Statistik - Jakarta  
Artha Graha - Jakarta  
Menara Prima - Jakarta  
Sentral Senayan - Jakarta  
Telkom Office - Bandung  
Jaya Mandiri Office - Tangerang  
Garuda Indonesia Building - Jakarta  
Jasa Raharja Office - Jakarta  
Slickbar Office - Jakarta  
Equity Tower - Jakarta  
Bej - Jakarta  
Graha Iis - Jakarta  
RT Bp. Daniel - Jakarta  
RT BP Niki Leon - Jakarta  
Sanyo - Cibitung  
Kantor Pajak - Balikpapan  
Graha Iip - Jakarta  
Kuta Bex - Bali  
Torabika - Banten  
Waterfront - Cikarang  
Griya Niaga - Jakarta  
Soewarna Bussines Park - Cikarang  
Astra Buana Office - Jakarta  
Trou Office - Jakarta  
Gkm Tower - Jakarta  
Tim - Jakarta  
Gedung Kantor Bandar Lampung  
Tanto Line - Surabaya  
Graha Warna - Warni Surabaya  
Rpl Office - Tangerang  
Jgc Office - Jakarta  
Cbp - Jakarta  
Mitra Armada Office - Magelang  
Kemang Village - Jakarta  
Meiji Office - Jakarta  
The Ritz Antasari - Jakarta  
Gd. C & Entrance Museum Nasional - Jakarta  
Kantor Paloma - Jakarta  
SS Tower - Jakarta  
Mojosari Office Connecting - Mojokerto  
DBS Tower - Jakarta  
Factory Sadhana - Jawa Timur  
Samsat Cikande - Serang  
BTPN Syariah - Jakarta  
Kimberly Jababeka - Cikarang

### GOVERNMENT OFFICE

Gedung PII - Jakarta  
Kejaksanaan Negeri Salatiga  
Gedung Lemsaneg

60

Kantor Bupati Sijunjung - Sumatera Barat  
Perum Peruri - Karawang  
Office ONE Jasa Marga  
PANGDAM / KODAM  
BI Jayapura  
Bank Indonesia - Lampung  
Departemen Agama - Jakarta  
Gedung DPR Probolingga  
Badan Pusat Statistik - Jakarta  
Telkom Office - Bandung  
Garuda Indonesia Building - Jakarta  
Jasa Raharja Office - Jakarta  
BPK Aceh - Aceh  
PLTGU - Bekasi  
BPK Lampung - Lampung  
BPK Ambon - Ambon  
BPK Penabur - Depok  
BPK Medan - Medan  
Mahkamah Yudisial - Jakarta  
Departemen SDA - Jakarta  
PTPN Sawit - Jambi  
Bea Cukai - Solo  
Bea Cukai - Bandung  
Telkomsel Buah Batu - Bandung  
BPPOM - Bandung  
Depnaker - Jakarta  
PMPN Aula - Sentul  
Gedung Kesenian - Surabaya  
PLN Bandung  
PLN Cirebon  
Gd. Balai Besar Wil. Citanduy - Banjar  
Gedung DPRD Sumbawa  
Gedung DPRD  
Bank Kredit Union - Pontianak  
BTN Palangkaraya

### MALL & SHOP

DM Banjarmasin - Banjarmasin  
Solo Paragon - Surakarta  
Carrefour Sunter - Jakarta  
Lobby Plaza - Bekasi  
Mitra 10 Kedungdoro - Jawa Timur  
Mitra 10 Karawang - Karawang  
Mitra 10 New - Pamulang  
Mitra 10 Bintaro - Tangerang  
Mitra 10 Cirebon  
Mitra 10 By Pass - Denpasar  
Mitra 10 Yogyakarta  
Mitra 10 Makassar - Makassar  
Mitra 10 New - Gading Serpong  
Mitra 10 New - Pasangrahan  
Mitra 10 New - Cibubur  
Planet Sport Q-Big  
Depo bangunan - Lampung  
Depo Bangunan - Bekasi  
Depo Bangunan - Bali  
Depo Bangunan - Alam Sutera  
Duta Mall - Banjarmasin  
RKM Cimahi - Cimahi  
Happy Puppy Bontang  
Top Food - BSD  
Mall Lippo - Cikarang  
Toko Electronic Sunter - Jakarta  
Minang Plaza - Padang  
Suzana Bakery - Surabaya  
Showroom Mazda  
Bakrie Epicentrum - Jakarta  
Artos Mall - Magelang  
Batam Factory - Batam  
New Armada Showroom - Magelang  
Grand City - Surabaya  
Art Shop - Bali  
RKM Pamanukan - Subang

Showroom Toyota - Semarang  
Toserba Selamat Cipayung - Puncak  
Ranch Market - Surabaya  
Banyuwangi Motor - (Yamaha)  
Plaza Balikpapan - Balikpapan  
Happy Puppy - Makassar  
Happy Puppy - Sidoarjo  
Gramedia World Bintaro - Jakarta  
Alfamidi Citra Raya  
Hartono Mall - Yogyakarta  
Restoran Ambrosia - Jakarta  
Happy Puppy LIBI Plaza - Denpasar  
RS Panti Rapih - Yogyakarta  
Kings Shopping Center - Bandung

### HOTEL

Orchardz Hotel - Kemayoran  
Hotel Everbright - Karawang  
Hotel St. Regis - Bali  
Arya Duta Hotel - Lippo Karawaci  
Hotel Basco - Minang  
Hotel Sensa - Bandung  
Hotel UNY - Yogyakarta  
Hotel Condotel - Balikpapan  
Hotel Mercure - Banjarmasin  
Hotel Mercure - TB Simatupang Jakarta  
Hotel Oasis - Bandung  
Hotel Quest  
Hotel Mulia - Jakarta  
Hotel Double Six - Bali  
Hotel Winner - Lampung  
Hotel Samuel Securitas - Jakarta  
Hotel The Brothers - Jakarta  
Hotel Yogya - Jawa Tengah  
IBIS Style Hotel - Jakarta  
Hotel IBIS Bandara  
Hotel IBIS Diponegoro  
Hotel IBIS Malioboro - Yogyakarta  
Hotel IBIS Seminyak - Bali  
Hotel POP - Lampung  
Hotel Amira Bandung  
Hotel Novotel - Pekanbaru  
Alana Hotel - Jawa Timur  
Hotel Harris - Jakarta  
Hotel Pullman Bandung  
Hotel Swissbell - Solo

### PUBLIC TRANSPORTATION

Terminal Bandara 2 Soetta - Jakarta  
Halte Busway Koridor Cililitan - Jakarta  
Sultan Iskandar Airport - Banda Aceh  
Bandara Sutan Thaha - Jambi  
Minangkabau Airport - Padang  
Meiji Office - Jakarta  
Adi Sucipto Airport - Yogyakarta  
Sultan Syarif Kasim II Airport - Pekanbaru  
Depati Amir Airport - Pangkal Pinang  
Timika Airport - Papua  
Komodo Airport - Labuan Bajo  
Soekarno Hatta Airport - Jakarta  
Juwata Airport - Tarakan  
Terminal Executive Bakaheuni - Lampung

# AND MANY MORE....

# Project References

## HOSPITAL

### JABODETABEK

RS Citra Garden City 5  
RS Pondok Indah  
Proyek Atmajaya  
RS Harapan Kita  
Jakarta Eyes Center  
RSUD Fatmawati  
Hospital Mayapada - TB Simatupang  
RS ANTAM Medika  
RSUD Tanjung Priok  
Puri Mandiri - Kedoya  
RS Nisa  
RS Ukrida  
Smart Marunda  
RS Medistra  
Ciputra Medical Center  
RSUD Pesanggrahan  
RSCM Kirana  
RS TNI AL Mintoharjo  
RS Mayapada  
RSUD Taman Sari  
RSUD Tarakan (Sky Hospital)  
Klinik Indrajana  
RS Husada  
Brawijaya Healthy Care Group  
RS Cimacan  
RS Leuwiliang - Bogor  
RS Pertamina - Sentul  
Bunda Aliyah - Depok  
RSUD - Cibinong  
RS Graha MM2100 - Cibitung  
RSIA Bina Medika - Bintaro  
RS Bhakti Asih  
RSUD Tangerang Selatan

### JAWA TENGAH

RSUD Prembun - Kebumen  
RS Blora  
RSUD - Temanggung  
RSUD Prof. Dr. Margono Soekarjo - Banyumas  
RS Tugu - Semarang  
SMC RS Telogorejo Semarang  
RS Colombia Asia - Semarang  
IBS ICU Terpadu RSUD - Semarang  
Mitra Bangsa - Pati  
PKU Muhammadiyah Mayong - Jepara  
PKU Muhammadiyah - Surakarta  
RS Brebes  
RSUD - Salatiga  
RS Purworejo  
RS JIH - Solo  
IGD RSKS - Pati  
OEN - Solo  
RS Akpol - Semarang  
RSUD Wongsonegoro - Semarang  
RSUD - Muntilan  
RSUD - Batang  
RSUD KRT Setjonegoro - Wonosobo  
RSUD Kardinah - Tegal  
IBS RSUD Hj Anna Lasmanah - Banjarnegara  
RSUD - Ambarawa  
RSUD Sragen  
RSUI Harapan Anda - Tegal  
RSUP Dr. Kariadi - Semarang  
RS PKU Muhammadiyah - Gombong  
RSUD Wongsonegoro  
RSGMP Unimus  
RS Sultan Agung - Semarang  
RS Indriati - Solo  
RS Indriati - Boyolali  
RS PKU Singkil - Tegal  
RS Bina Husada - Rembang  
RS Priscilla Cilacap

RSIAD Purbalingga  
RSI Kudus  
RSUD Dr. Loekmono Hadi Kudus  
RS Amal Sehat - Sragen  
RS Ibnu Sina - Sragen

### D.I YOGYAKARTA

PKU Muhammadiyah  
RSGM UGM  
RS Saptosari  
RS UII  
RS UMY  
RS Panti Rapih  
RSUP Dr. Sardjito  
RS JIH  
RSUD Wates Kulon Progo  
RSI Hidayatullah  
RSUD Bantul  
RSUD - Sleman  
RSGM UMY  
RSUD Penembahan Senopati Bantul

### JAWA BARAT

RS Hasan Sadikin - Bandung  
RS Persada Medik  
RSIA Permana Pertiwi  
RS Dustira  
Melinda Hospital  
RSUD Langensari  
RSKIA Bandung

### JAWA TIMUR

RS Haji - Surabaya  
RS Unair - Surabaya  
Delta Surya - Sidoarjo  
RSUD - Mojokerto  
SILOAM Hospital - Surabaya  
RS Adi Husada - Surabaya  
RS Cendana Kanigoro - Blitar  
Gedung Radio Terapi RS Malang  
RS Lavayette - Malang  
RSUD Dr. Soetomo - Surabaya  
RS Adhi Husada - Surabaya  
RSMU Blitar  
RS Medika Mulia - Tuban  
IGN Tahap II 18 RSUD - Sidoarjo  
RS Islam - Malang  
RSUD Sidoarjo  
RSUD Bangkalan - Madura  
RS Al Huda - Banyuwangi  
RS Mata Undaan - Surabaya  
RS Muhammadiyah Babat - Lamongan  
STOC 18 (Gedung STOC Dr. Soetomo)  
RS Karsa Husada  
RS Jombang  
RS Lumajang  
RSUD Srengat Blitar  
RSUD Soedono Madiun

### SUMATERA

RS Ibnu Sina - Padang  
RS Unand - Padang  
RS Hanafiah Batu Sangkar  
RSUD Padang Panjang  
RS Awal Bross - Pekanbaru  
RSUD Arifin Ahmad - Pekanbaru  
RSUD IDI - Aceh Timur  
RS Semen Padang  
Murni Teguh - Medan  
RS Adam Malik - Medan  
RS Charitas - Palembang  
RS Pelabuhan - Palembang  
RSJ Tampilan - Riau

RS Harapan Bunda - Banda Aceh  
RSUD - Meulaboh  
RSUD Duri - Riau  
Awal Bross - Batam  
RS KIM - Pangkal Pinang  
RS Universitas Andalas  
RS BP Batam  
RS Tiara Sella - Bengkulu  
Sufina Aziz - Medan  
RS Datu Beru - Aceh  
RS Paru - Lubuk Alung  
RS Rasiding - Padang  
RS Kim Pangkalpinang  
RSUD Rivai Palembang  
RS Harapan Bunda Aceh

### BALI

RSUD Klungung  
RSUD Gianyar  
RSUD Wangaya  
RS Balimed Buleleng  
RSPTN Universitas Udayana  
Badung Blok E  
RS Mata Balimandara - Denpasar  
RS Mata Balimandara - Sanur  
RSUD Mangusada - Badung  
RSUD Negara - Jembrana  
RSUP Sanglah  
RS Kasih Ibu - Denpasar  
RS Kasih Ibu Saba  
RS Kasih Ibu - Tabanan

### KALIMANTAN

RS Banjar Baru  
RSUD Tenggarong  
Pontianak Hospital  
RSUD Balikpapan  
Benawa Raya  
Ciputra Mitra Hospital - Banjarmasin  
RSUD Dr. Agoesdjam Ketapang  
RS Pertamina Tarakan

### SULAWESI

RS Gorontalo  
RS Madani - Palu  
RSUD Undata - Palu  
RS Siloam - Manado  
RS Manado  
RSUD - Konawe  
RSUP Tadjudin Chalik - Makassar  
RS Bhayangkara - Makassar

### NUSA TENGGARA BARAT

RSUD Mataram  
RS Islam - Lombok Timur  
IGD RSUD Mataram  
RSUD NTB  
RS Ibu Dan Anak Lombok Timur

### NUSA TENGGARA TIMUR

RSUD Manggarai Timur - Flores  
RSUD Ben Mboi  
RSUD - Kupang

### MALUKU

RS UPT Vertikal - Ambon

### PAPUA

Provita - Jayapura

AND MANY MORE....

# Project References

## HOME LIVING

### JABODETABEK

Osim Grand Indonesia - Jakarta  
Kemenkeu - Jakarta  
Hotel Pamelor - Jakarta Selatan  
RT Tomang - Jakarta  
Gedung Kesenian Jakarta  
RT Bpk Rahman - Jakarta  
Immigrant - Pondok Indah  
Share Tea Taman Angrek - Jakarta  
Sour Sally - Taman Angrek - Jakarta  
RT Bpk Anthony - Menteng  
RT Bpk Joko - Cillitan  
RT Bpk Zaki - Jakarta Selatan  
RT Bpk Irwan Kebon Jeruk - Jakarta  
RT Bpk Doni - Jakarta Selatan  
Gedung BEI  
Bpk Firdaus - Taman Angrek  
Potato Head - Jakarta Selatan  
RT Bpk Chanafi - Jakarta Barat  
Masjid Bani Umar - Bintaro  
RT Bpk Marco - Jakarta  
RT Bpk Ahin - PIK Jakarta Pusat  
RT Bpk Andri - PIK Jakarta  
FX Binus Sudirman - Jakarta Pusat  
RT Ibu Drg. Meike - Jakarta Barat  
RT Ibu Drg. Meike - Jakarta Barat  
TB 41 - Jakarta Pusat  
Kemang Timur VI  
Patio Central Park - Jakarta  
Bp. Suria - Jakarta  
RT Bpk Andre - Kosambi  
PT, Multi Graha Mitratama - Jakarta  
Apartement Somerset - Jakarta  
PT Putra Samudra Mas - Jakarta  
RT Bpk Aditya  
RT Bpk Halim  
Gedug Sucaco Lt 5 - Jakarta  
RT Ibu Asty - Senayan  
RT Bpk Surono - Sunter  
RT Bpk Gunawan - Kelapa Gading  
RT Ibu Aci House - Pondok Indah  
SML - Grand Indonesia  
Crocs - Grand Indonesia  
Harvey Nicols - Grand Indonesia  
Kemang Timur  
RT Bpk Joko- Pondok Indah  
RT Ibu Aprilia - Jakarta  
PT AstoriaProyek Graha MRA - Jakarta  
RT Koh Andy Hong - Jakarta  
RT Pejaten - Jakarta  
Cilandak Kav 16 s/d 19  
RT Tinggal H. Soleh - Mampang  
HHP Sudirman  
RT Bpk Vincen Daan Mogot  
Paud UHAMKA  
Kantor PT Himalaya  
PT Morphasia  
Roxy Glass  
RT Bpk Gigih  
RT Bpk Amir Juharto  
Indofood CBP  
RT Cibinong

Summarecon - Cisarua  
RT Cipayung  
PT. Allianz Neo Soho  
RT Bpk Andi Wijayanto - Alam Sutra  
Four Wings of Senayan - Tangerang  
RT Bpk Iwan Haimin - Bintaro Jaya  
Gedung Kantor PT Arkonin  
RT Bpk Ali - BSD  
RT Bpk Andrias - Bintaro  
Gedung BCA Syariah  
RT Ibu Jetty - Bogor  
RT Bpk Lim - Bogor  
Cibitung (INOAC POLYTECHNO Karawang)  
RT Ibu Sri - Tangerang Selatan  
RT Bpk Jerry - Serpong  
RT Ibu Rina - Tangerang  
Cluster Emerald Utara - Pondok Hijau Golf  
UPH Karawaci  
Kubikahomy - BSD  
Urban Icon - Mall Sumarecon Bekasi  
RT Bpk Amir Juniarto  
RT Bpk Patrick  
RT Bpk Edi Sugianto - Bekasi  
RT Ibu Evi - Bekasi  
RT Bpk Yozart - Tangerang  
Hotel Olive Karawaci - Tangerang  
RT.BP Arie Wisianto - Tangerang  
RT Bpk Juki - Serpong Tangerang  
RT Bpk Gunawan - Tangerang  
Festive Walk Karawang  
RT Bpk Rusdi  
RT Ibu Risna  
RT Bpk Acing - Karawang Barat  
Nafiri Living World - BSD Tangerang  
Green Lake City

### JAWA BARAT

Trans Hotel Bandung  
RT Bpk Halim  
RSUD Bandung  
Auto 2000 - Sukabumi  
Hotel Amira - Bandung  
RT Bpk Hendry  
RT Bpk Sofyan  
Garage Cirebon  
Auto 2000 Majalengka  
RT Bpk Agoes Djaja  
RT Bpk Daniel  
RT Bpk Hadi  
RT Bpk Gigih  
RT Ibu Ella  
RT Bpk Tody - Caribian  
RT Bpk Edi Darnadi  
RT Bpk Edi Sugianto  
Wisata Bumi Mas  
Kampus Pelita Bangsa  
RT Bpk Niko  
RT Bpk Sanjaya

### JAWA TENGAH

RT Bpk Topaz Kuntadi Jogja  
Airlangga Semarang - Semarang

RT Bpk Andi - Bale Mulia Jogja  
WR Simpang Lima  
RT Ibu Rian  
RT Ibu Rila  
RT Bpk Tommy  
RT Bpk Dedy  
CV. Cipta Adikarya Nusantara Dipta  
RT Ibu Yuli  
Hartono Wignjopranoto  
RT Ibu Lani - Solo  
RT Bpk David  
RT Ibu Siti Arafah  
RT Ibu HJ Humaeroh  
Grasia Visi Pratama

### JAWA TIMUR

RT So Suki - Surabaya  
Rumah Tinggal Bpk Suprianto  
Rumah Tinggal Arijati Suliarta  
RT Bpk Edi  
RT Koh Frengky  
Rumah Tinggal Ibu Siska - Surabaya  
RT Ibu Widya  
The Edge 2Proyek RT Bpk Wahyu  
RT Ibu AnaBALI  
Alila Uluwatu - Bali  
Ramada Hotel & Suites sakala - Bali  
Delta Bali - Bali  
Alila Uluwatu - Bali  
Double Six - Bali  
Seminyak Resort Bali  
Canggu Bali  
Restauran Bali - The Banjar

### SUMATERA

PT Cendrawasih Mulo Ano - Padang  
RT Bpk Akhmad  
RT Bpk Fajar - Medan  
RT Lampung  
Asrama Polres - Medan  
PURI B6  
PT Surya Alumindo Sejahtera - Pekanbaru  
Teluk Betung 41  
RT Bpk Athjeng  
B Nus Northumbria In  
Woodland  
Hotel Harris  
RT Bpk Farid  
RT Bpk Heri - TSI

### KALIMANTAN

RT JI Rubiini - Pontianak  
Golden City - Pontianak  
RT Bpk Albert  
RT Ibu Vivi  
RT Bpk Iwan  
Rumah Tinggal Bpk Wihartono

# AND MANY MORE....





# PROVIDING SERVICE & MAINTENANCE

for all Automatic Door Brands

## RELIABLE AFTER-SALES SERVICE



### Customer Service 24/7

Prioritizing customer service and satisfaction



### Reliable Technician

Reliable and experienced technicians



### After-Sales Service

Spare Part provider, handling troubles, up to maintenance contract

## SERVICE WARRANTY

Availability of original and complete spare parts

After-Sales Service

 0812 2013 232



**Selaras Lawang Sewu**  
Door & Window Solution

## **HEAD OFFICE**

Daan Mogot km. 19 Kawasan Pergudangan  
Tunas Blok A3 No. 7, Jl. Laksamana Yos Sudarso,  
Kel. Kebon Besar, Kec. Batu Ceper, Tangerang

HP : • 0888 1000 300    Tip : • 021 2252 3937  
          • 0888 1000 330    • 021 2252 3938  
Fax : 021 2967 1465

## **BRANCH OFFICE**

Jl. Tumpang Raya No. 39,  
Kecamatan Gajahmungkur,  
Kota Semarang, Jawa Tengah

HP : 0888 1000 200  
Tip : 024 76420883

🌐 | [www.selaraslawangsewu.com](http://www.selaraslawangsewu.com)

📱 | [selaraslawangsewu\\_official](https://www.instagram.com/selaraslawangsewu_official)

📘 | [Selaras Lawang Sewu](https://www.facebook.com/SelarasLawangSewu)



SCAN ME

